



# Fizeau Wavemeter and Fibre Switcher

*FZW600 + FSM2, FSW4, FSW8*



Firmware v0.10.3, mogfzw v1.9.2

## Limitation of Liability

MOG Laboratories Pty Ltd (MOGLabs) does not assume any liability arising out of the use of the information contained within this manual. This document may contain or reference information and products protected by copyrights or patents and does not convey any license under the patent rights of MOGLabs, nor the rights of others. MOGLabs will not be liable for any defect in hardware or software or loss or inadequacy of data of any kind, or for any direct, indirect, incidental, or consequential damages in connections with or arising out of the performance or use of any of its products. The foregoing limitation of liability shall be equally applicable to any service provided by MOGLabs.

## Copyright

Copyright © MOG Laboratories Pty Ltd (MOGLabs) 2017 – 2026. No part of this publication may be reproduced, stored in a retrieval system, or transmitted, in any form or by any means, electronic, mechanical, photocopying or otherwise, without the prior written permission of MOGLabs.

## Contact

For further information, please contact:

MOG Laboratories P/L  
49 University St  
Carlton VIC 3053  
AUSTRALIA  
+61 3 9939 0677  
info@moglabs.com

MOGLabs USA LLC  
419 14th St  
Huntingdon PA 16652  
USA  
+1 814 251 4363  
www.moglabs.com

# Contents

|  |            |
|--|------------|
| <b>Getting started</b>                               | <b>iii</b> |
| <b>1 Introduction</b>                                | <b>1</b>   |
| 1.1 How it works . . . . .                           | 1          |
| 1.2 Features . . . . .                               | 2          |
| <b>2 Connections and controls</b>                    | <b>3</b>   |
| 2.1 Front panel interface . . . . .                  | 3          |
| 2.2 Rear panel controls and connections . . . . .    | 4          |
| 2.3 Device UI . . . . .                              | 5          |
| 2.4 Web UI . . . . .                                 | 8          |
| <b>3 mogfw</b>                                       | <b>9</b>   |
| 3.1 Device discovery . . . . .                       | 9          |
| 3.2 Main display . . . . .                           | 10         |
| 3.3 Menu . . . . .                                   | 11         |
| 3.4 Time-series measurement . . . . .                | 12         |
| 3.5 PID configuration . . . . .                      | 14         |
| 3.6 Switch . . . . .                                 | 15         |
| <b>4 Operation</b>                                   | <b>17</b>  |
| 4.1 Fringe identification and optimisation . . . . . | 17         |
| 4.2 Auto-exposure algorithm . . . . .                | 20         |
| 4.3 Reducing noise . . . . .                         | 20         |
| 4.4 Wide and fast modes . . . . .                    | 20         |
| 4.5 Pulsed lasers . . . . .                          | 21         |
| 4.6 Measurement averaging . . . . .                  | 22         |
| 4.7 Calibration adjustment . . . . .                 | 23         |

---

|          |   |           |
|----------|---|-----------|
| <b>5</b> | <b>PID locking</b>                                | <b>27</b> |
| 5.1      | Using with MOGLabs DLC laser controller . . . . . | 28        |
| 5.2      | PID parameters . . . . .                          | 28        |
| 5.3      | Integrator windup . . . . .                       | 30        |
| 5.4      | Examples . . . . .                                | 31        |
| <b>6</b> | <b>Optical switch</b>                             | <b>37</b> |
| 6.1      | Overview . . . . .                                | 37        |
| 6.2      | 2x1 switch modules . . . . .                      | 37        |
| 6.3      | MOGLabs FSW fibre switches . . . . .              | 37        |
| 6.4      | mogfzw switch UI . . . . .                        | 42        |
| 6.5      | Drift correction . . . . .                        | 46        |
| 6.6      | Multiple FSW . . . . .                            | 48        |
| <b>A</b> | <b>Specifications</b>                             | <b>49</b> |
| <b>B</b> | <b>Command language</b>                           | <b>53</b> |
| B.1      | General functions . . . . .                       | 53        |
| B.2      | Display . . . . .                                 | 54        |
| B.3      | Measurement . . . . .                             | 54        |
| B.4      | Camera . . . . .                                  | 57        |
| B.5      | Optical switch . . . . .                          | 59        |
| B.6      | Control voltage out and PID . . . . .             | 62        |
| B.7      | Ethernet configuration . . . . .                  | 63        |
| <b>C</b> | <b>Firmware updates</b>                           | <b>65</b> |
| <b>D</b> | <b>Errors and troubleshooting</b>                 | <b>67</b> |
| <b>E</b> | <b>Communications</b>                             | <b>69</b> |
| E.1      | Protocol . . . . .                                | 69        |
| E.2      | TCP/IP . . . . .                                  | 69        |
| E.3      | USB . . . . .                                     | 71        |
| <b>F</b> | <b>Dimensions and PCB</b>                         | <b>73</b> |
| F.1      | Connectors . . . . .                              | 76        |

# Getting started

1. **Connect to power** via the USB port or the DC barrel jack.

When powering with USB, it is important that the host can supply up to 600 mA. Some older computers may detect this as a short-circuit and power down the device; USB-3.0 compliant hubs are recommended.

2. **Power on** using the rocker switch on the rear.

3. **Connect fibre** using the supplied fibre patchcord. Typically this is FC/APC (green) at both ends, for FZW600-APC versions. For the FZW600-PC version, a patchcord with FC/PC (black) end must be connected to the FZW.

Single-mode fibres are strongly preferred, although small-core multi-mode fibres (up to 62.5  $\mu\text{m}$ ) can be used at the expense of reduced accuracy.<sup>1</sup>

4. **FSW Fibre switch:** If using a fibre switch, connect the output fibre from the switch to the input fibre port on the FZW. Electrically connect the FSW and FZW using the supplied M8 cable. Connect your light source via fibre to one of the 4 or 8 input ports on the FSW.

5. **Input light** with the supplied free-space to fibre adapter. Typically the FZW only needs a few microwatts to operate, so high coupling efficiency is not required. The *saturation* (Figure 1) is a measure of the power reaching the detector

The auto-exposure algorithm tunes the exposure time and sensor gain to match the input power and optimise the measurement rate. Manual settings may be preferable, for example if the laser power is rapidly fluctuating.

---

<sup>1</sup>Absolute accuracy specifications are only valid when using single-mode fibres.

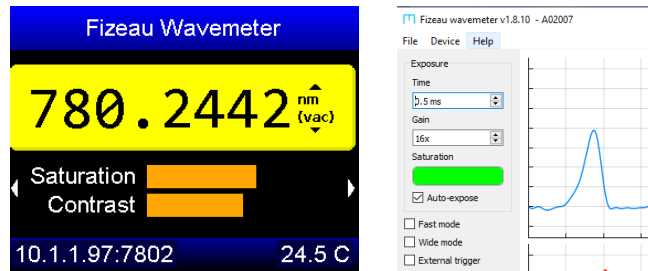

**Figure 1:** Both the built-in wavemeter display (left) and host software (right) provide saturation indicators that measure the optical power reaching the detector.

That's it: with a coupled fibre you should be able to read the wavelength within two seconds of power-on. It is recommended to periodically inspect the measured interference fringes for correct structure (§4.1) to ensure reliable measurement.

Typically the FZW will reach thermal equilibrium and full accuracy within 15 minutes of being turned on. The most accurate results will be obtained in a well-stabilised lab environment. It is recommended that the FZW not be in thermal contact with any other equipment to prevent formation of thermal gradients.

## Host connection

The recommended mode of operation is using the Windows™ host application (chapter 3) which provides a simple interface for controlling device functionality. Instructions for connecting via ethernet and USB are provided in Appendix E.

# 1. Introduction

## 1.1 How it works

The FZW is a high-precision device that measures laser wavelengths using a set of Fizeau interferometers. A Fizeau interferometer is formed by two planar surfaces with a small wedge angle between them, which generates spatially-varying interference fringes as the optical path length changes (Fig. 1.1). Both the fringe spacing and phase of the resulting interference pattern are related to the wavelength of the incident light, so analysing their structure allows precise determination of the laser wavelength.

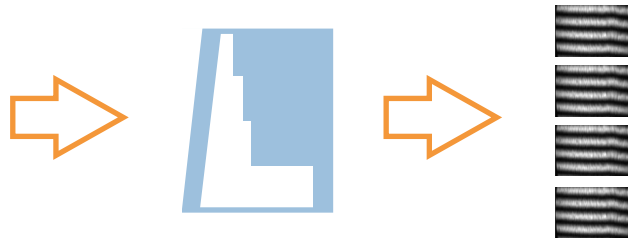

**Figure 1.1:** Collimated monochromatic laser light and Fizeau etalons create interference patterns on an imaging detector. The wavelength is calculated by combining measurements of the fringes from four different etalons.

A rough estimate of the wavelength is obtained directly from the fringe spacing, to an absolute accuracy of one part in 100. This initial estimate is then improved by the phase of the fringe pattern. Multiple etalons with different free-spectral ranges (FSRs) are used to refine the wavelength measurement without sacrificing absolute accuracy. The MOGLabs FZW uses four such stages, with the FSR of the final etalon being 7.5 GHz. This enables the wavelength to be determined to an absolute accuracy of one part in  $10^7$ .

## 1.2 Features

The MOGLabs FZW has no moving parts, and very high sensitivity semiconductor imaging, enabling high measurement speed (up to 320 per second) and measurement of pulsed sources with only a few microwatts of light.

Long lifetime is assured as there are no mechanical parts to wear out. The etalons are optically-contacted fused silica, with a low thermal expansion coefficient, making the instrument incredibly robust, reliable, and stable. High precision MEMS-based sensors are used to make small corrections for environmental variations. Recalibration is not required to maintain the stated accuracy; in fact, the FZW is more stable than the neon lamp used in some other wavemeters as a calibration source.

The FZW also integrates a modern 32-bit microprocessor and high-resolution compact colour display. Wavelength calculation is performed automatically on the device so that no host computer is required. It is compact and can be powered from USB or even a rechargeable battery, so you can move it around your lab and measure wavelength right where you are adjusting your laser.

Fast ethernet and USB communications combined with a sophisticated software suite enable display on your lab computer or your smartphone. Multiple FZW devices can be easily run from a single computer, and integration with common data acquisition systems is simple using text-based commands over standard protocols, with simple bindings to LabVIEW, MATLAB, and python provided. PID frequency feedback locking is also included with every device, also without requiring a host computer.

## 2. Connections and controls

### 2.1 Front panel interface

The FZW front panel (Figure 2.1) includes an interactive colour screen with push-button interface, and a number of status indicator lights. This allows autonomous usage of the wavemeter independently of a computer.

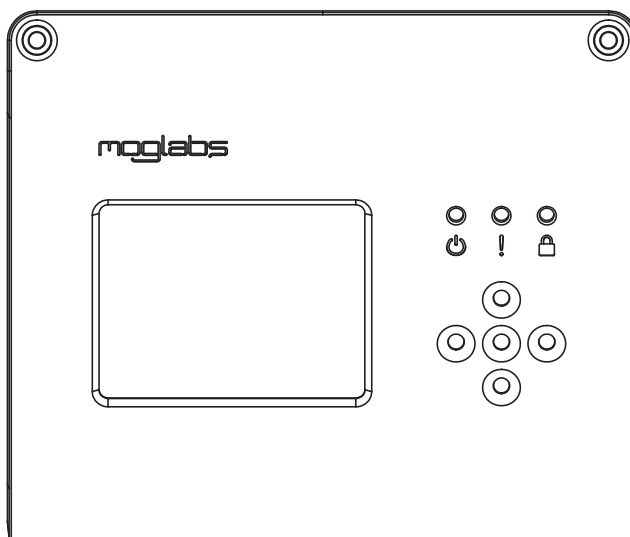





Figure 2.1: MOGLabs FZW front panel layout.

The buttons are arranged with up, down, left and right buttons, and an additional **OK** button in the centre. In wavelength display mode, the up/down buttons change the display units, and the left/right buttons swap between different diagnostic modes (see Figure 2.2). Pressing **OK** opens the menu system.

The display includes a *sleep mode* which reduces the brightness when not in use. Where this feature is undesirable it can be disabled by setting the sleep time to zero in the menu system.

The LED indicators display the current state of the device, as listed in the table below.

| Indicator  | Colour | Status                       |
|--|--------|------------------------------|
| PWR   | Off    | Unit is powered off          |
|  | Green  | Normal operation             |
|  | Blue   | Firmware update mode         |
| ERR   | Off    | No measurement in progress   |
|  | Green  | Normal operation             |
|  | Yellow | Measurement error            |
|  | Red    | Critical device error        |
| LOCK  | Off    | PID/analogue output disabled |
|  | Green  | PID locked                   |
|  | Yellow | PID engaged but not locked   |
|  | Red    | PID output saturated         |
|  | Blue   | Analogue output error        |

## 2.2 Rear panel controls and connections

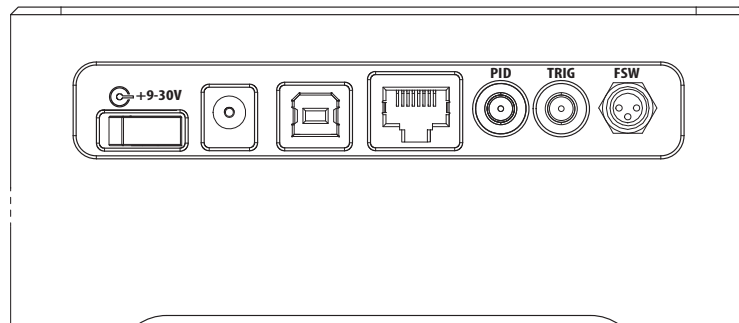

Figure 2.2: MOGLabs FZW Rev4 rear panel layout.

From left to right, the features of the rear panel (Figure 2.2) are:

**Power switch** Switches the unit on/off.

**DC supply** 2.1mm centre-positive barrel-jack connector for supplying power the

unit. Not required if power is supplied over USB. Use of a floating (unearthed) plugpack power supply is not recommended. Use +5 V for Rev1 to Rev3; +9 to +30 V for Rev4 devices.

- USB** Standard USB type-B connector for powering and/or communicating with the device. When used to power the device, must be connected to a USB port capable of supplying 600 mA.
- Ethernet** RJ-45 jack for 10/100 MB/s TCP/IP communications, which is the recommended interface for computer control and monitoring.
- PID** Analogue output port for wavelength monitoring or PID control of laser wavelength (see chapter 5). 16-bit resolution with  $\pm 2.5$  V output range.
- TRIG** TTL input for synchronising the wavemeter measurement to an external trigger (see §4.5.1).
- FSW** M8 connector for interfacing with the FSW4/FSW8 multi-channel optical switcher (see chapter 6).

## 2.3 Device UI

The FZW includes an integrated user interface for operating the wavemeter independently of a host computer. The primary display shows the currently measured wavelength (Figure 2.3) in units that can be selected via the up/down buttons.

The *saturation* is a measure of the optical power reaching the detector, and the *contrast* is a measure of fringe quality. In general, higher saturation is preferred as this permits faster measurement, however oversaturation (as indicated by the bar turning red) will degrade measurement accuracy.

Pressing the left/right buttons changes to an alternate display mode (Figure 2.4), permitting diagnostic of the fringe pattern as explained in §4.1, as well as displaying a rudimentary time-series of variations

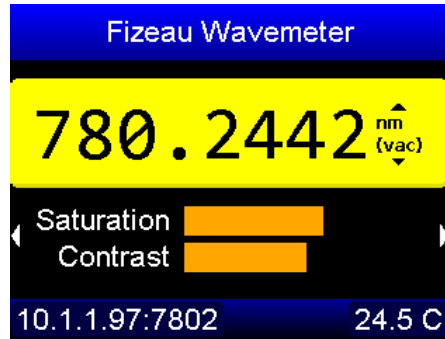

Figure 2.3: Primary wavelength display showing the measured wavelength, saturation and contrast, as well as the device IP address.

in the measured wavelength over time. Pressing the central OK button opens the menu system (see §2.3.1).

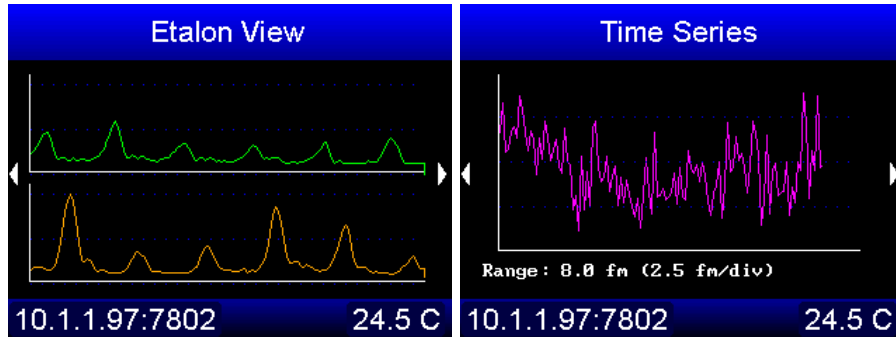

Figure 2.4: Diagnostic modes of the FZW device UI: etalon display (left) permits verification of fringe quality, and time-series display (right) shows variation in the measured wavelength over time.

### 2.3.1 Menu system

The menu system allows for interactive control of the device without a computer interface (Figure 2.5). It is started by pressing the **OK** button from the measurement display mode, and exiting by pressing

the left directional button.

Within the menu system, the up and down buttons control the selected item. Pressing **OK** on a selected item activates it to allow editing the value, entering the submenu, or executing the command. Pressing the left button returns to the previous menu, or exits the menu system.

When a value is selected for editing, a digit will be highlighted. Using the up/down keys modifies this digit, and using the left/right keys changes which digit is selected. Pressing **OK** again exits editing mode.

| Settings Menu          | Device Options            |
|------------------------|---------------------------|
| Reset measurement      | Ethernet ▶                |
| Exposure time: 0.33 ms | Display contrast: 100 %   |
| Exposure gain: 120     | Display sleep timer: 30 s |
| Autoexpose: ON         |                           |
| Device options ▶       |                           |
| 10.1.1.97:7802 25.7 C  | 10.1.1.97:7802 25.7 C     |

**Figure 2.5:** Primary settings menu, showing measurement options (left) and device settings (right) which includes display settings.

| Ethernet Settings               | Ethernet Settings      |
|---------------------------------|------------------------|
| Current IP:<br><b>10.1.1.97</b> | IP Mask: 255.255.255.0 |
| Static IP: 10.1.1.190           | Gateway: 10.1.1.1      |
| IP Mask: 255.255.255.0          | Port: 7802             |
| Gateway: 10.1.1.1               | DHCP: ON               |
| 10.1.1.97:7802 25.7 C           | Restart ethernet       |
|                                 | 10.1.1.97:7802 25.8 C  |

**Figure 2.6:** The Ethernet settings menu provides control of connection settings (left), including DHCP and static addresses. Any changes only take effect once the Ethernet controller is restarted (right).

In particular, it is useful for configuring the Ethernet settings in a networking environment where DHCP is disallowed (Figure 2.6). In this situation, an appropriate static IP should be allocated to the unit, the gateway set as required by the network configuration, and DHCP set to OFF.

## 2.4 Web UI

The FZW includes a simple web interface for monitoring the device remotely through a web browser, such as using a smartphone. Navigating to the device IP address displays the currently recorded wavelength, which is automatically updated (Figure 2.7). At present this interface doesn't provide control options, but increased functionality will be provided in future firmware updates. In environments where

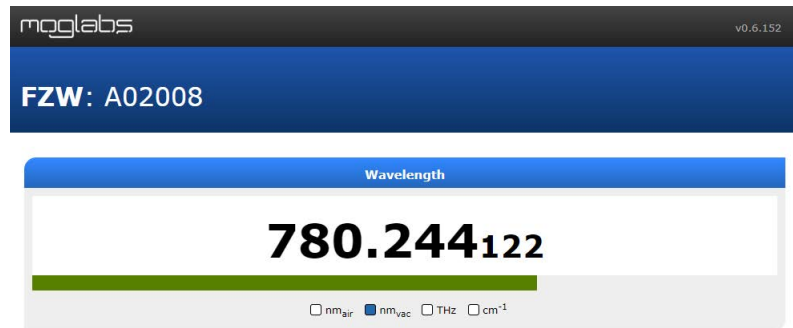

**Figure 2.7:** The integrated web interface shows measured wavelength and saturation (represented by the coloured bar).

embedded devices running web servers constitute a security concern, the web interface can be disabled using the command `ETH,WEB,0` or through the Menu System by selecting

Options→Ethernet→Web server→OFF.

# 3. mogfzw

mogfzw is a fully-featured control and diagnostic program suite for Windows™ operating systems, available from the MOGLabs website.

## 3.1 Device discovery

By default, a device discoverer (fig. 3.1) is initiated when mogfzw is started. The discoverer scans the USB ports of the host computer looking for a FZW device, and then scans the local network subnet. Starting the application is then as simple as double-clicking on the device, or click to select and then click on *Connect*. If the network

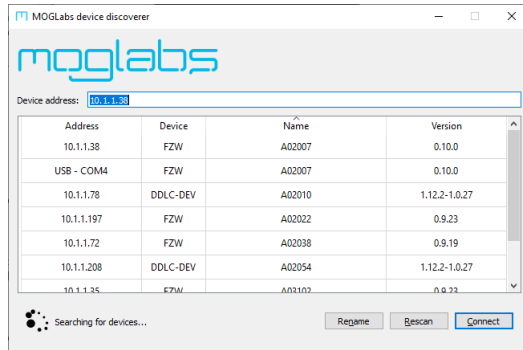

Figure 3.1: Example of the *device discoverer* window.

does not permit device discovery and/or your FZW does not appear in the list, it is possible to enter the IP address of the unit in the *Device address* box and connect regardless.

The discoverer will not start if the connection is specified in the default configuration file or on the command line or equivalent shortcut link.

## 3.2 Main display

Most of the user interface is dedicated to displaying the etalon fringes, which are important for measurement diagnostics (see §4.1). The wavelength display box has selectable units, and can be resized to increase the font size and make the measurement easier to read from a distance.

The exposure controls on the left-hand side include a scale bar showing the optical saturation. Both the exposure time and camera gain can be manually adjusted, although in most scenarios the auto-exposure algorithm will optimise these values.

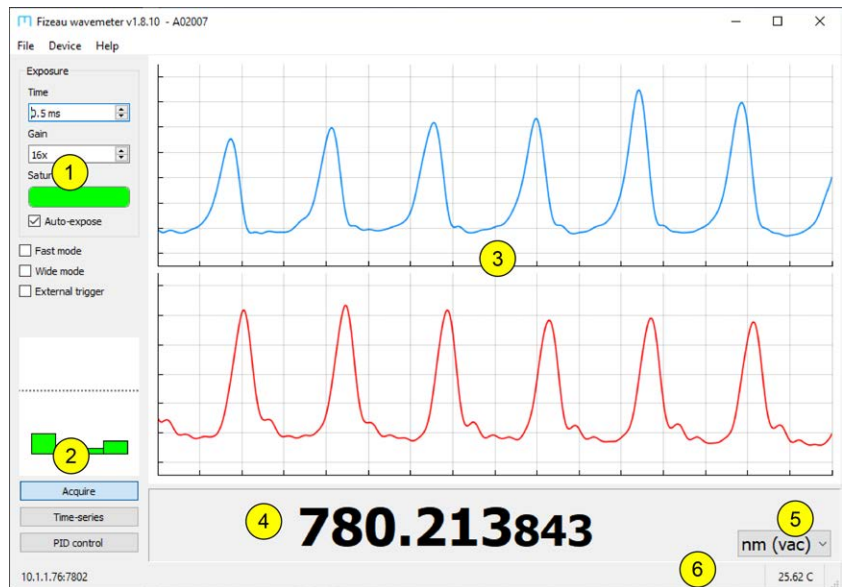

**Figure 3.2:** The host software interface, showing (1) exposure controls, (2) convergence monitor, (3) interference fringes for a short etalon (upper) and the long etalon (lower), (4) measured wavelength, (5) display units selector, (6) etalon temperature and (7) communication address. The font size of the measured wavelength can be enlarged by dragging the splitter bar vertically.

The *convergence monitor* on the lower-left indicates how stable the iterative measurement is. In most situations the bars should remain below the dotted line, indicating that the iterative algorithm is converging reliably. In situations where the laser wavelength is changing rapidly, or the calibration has been perturbed, the bars may exceed the indicated region indicating the reliability of the measured value is reduced.

## 3.3 Menu

### 3.3.1 File

**Record CSV** Starts and stops recording of measurements to a CSV file. A dialogue will pop up requesting a time interval between recordings, and then another dialogue for the filename and location. A suggested filename is autogenerated using the current date and time.

If a switch is connected, Record CSV will save the frequency for each valid fibre switch channel, but only while the Switch window is open. Otherwise, it will save the laser frequency for the currently selected switch channel.

**Save debug** Saves technical information which can be sent to MOGLabs to assist with diagnosis of problems.

**Firmware update** See appendix C for instructions on updating the FZW firmware.

### 3.3.2 Device

**Reconnect** If connection to the FZW device is lost due to communications errors, for example due to a network outage or a cable misconnect, use Reconnect to attempt reconnecting.

**Rename device** Assign a new name to each hardware device, which is useful to help identify a specific FZW when the Device Discoverer finds multiple units.

**Commander** Opens a new dialog for interactive command access to the device,

similar to `telnet` but this approach will work via USB. Type a command into the command line window, and hit `Enter` to send that command to the device (see appendix B); the response will appear in the box below the command line window.

**Show convergence** Enable or disable the convergence bar display.

**Show all lineouts** The FZW has four Fizeau etalons. The top etalon trace in the main window typically shows only one, but Show all lineouts can be used to show the missing etalons. It can be useful to see if for some reason one of the traces has very different contrast or amplitude.

**Upload/download calibration** Calibration data is saved in non-volatile memory on the device. To protect against memory corruption, it is a good idea to download that data and save it, and then to upload if needed.

**Calibration adjustment** Small adjustments to the calibration, for example to improve the absolute accuracy near a wavelength of interest, sacrificing some accuracy across the full wavelength range. See section §4.7.

### 3.3.3 Help

**About** Shows device serial number and firmware versions. Please send this information to MOGLabs if product support is needed.

**Check for updates** Checks the MOGLabs website for firmware updates.

**Manual** Opens a web browser on the device home page, where the user manual can be found.

## 3.4 Time-series measurement

*Time-series* opens a window showing the measured wavelength against time (fig. 3.3). This can be beneficial for measuring long-term drifts in laser wavelength, and diagnosing PID locking. Click and drag the left or right mouse button in the plot area to adjust the vertical offset and scale.

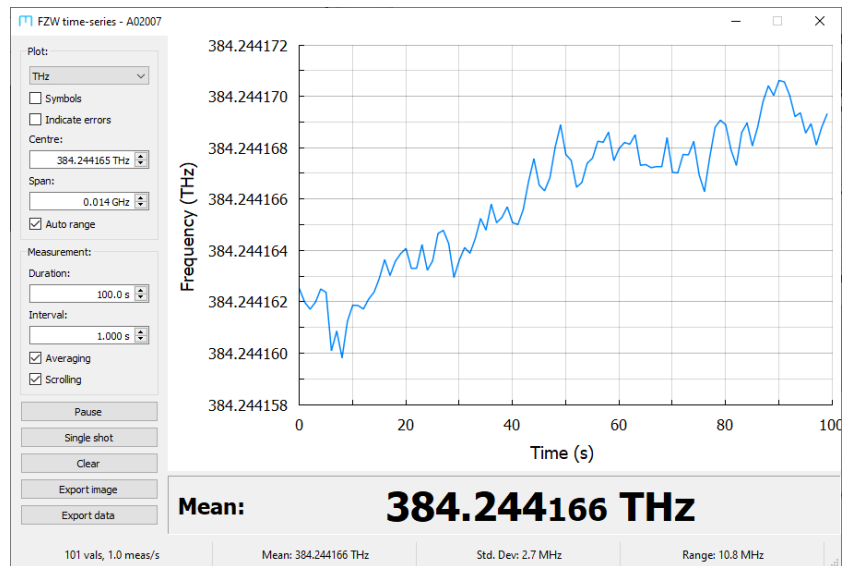

**Figure 3.3:** *Time-series* displays wavelength variation with time, where *Duration* is the time extent, and *Interval* is the time between each measurement. With *Averaging* enabled, the measurements are averaged over each interval.

### 3.4.1 Scan-range measurement

The time-series feature can also be used to display rapid measurements, where the *measurement interval* is set to zero. This can be useful, for example, to measure the mode-hop free scan range of a tunable laser (fig. 3.4). Note that at the end of the laser scan, the wavelength changes very rapidly and can cause the wavelength to vary non-trivially *during* the camera exposure, which may cause a jump in the measured wavelength at this point.

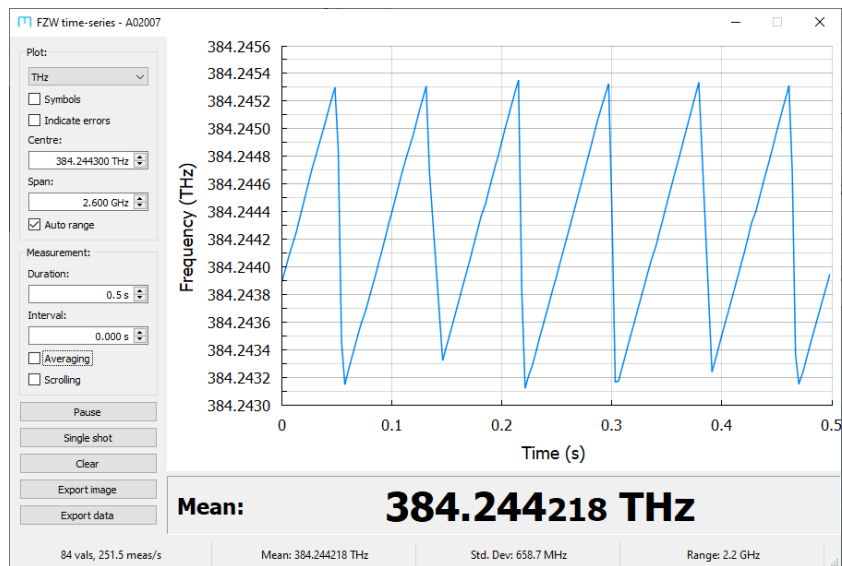

**Figure 3.4:** The FZW can be used to measure the mode-hop free scan-range of a laser. With *Interval* set to zero, measurements are recorded as rapidly as possible. The measurement rate, mean, standard deviation and peak-to-peak range are shown in the status bar at the bottom.

### 3.5 PID configuration

The application also includes a window for adjusting the constants used for the PID control loop; see section chapter 5 for a detailed discussion.

## 3.6 Switch

Figure 3.5 shows the app when an optical switch is connected to the FZW. The PID button is removed and a Switch button added, to open a new window for monitoring and controlling the switch channels. See chapter 6 for more information.

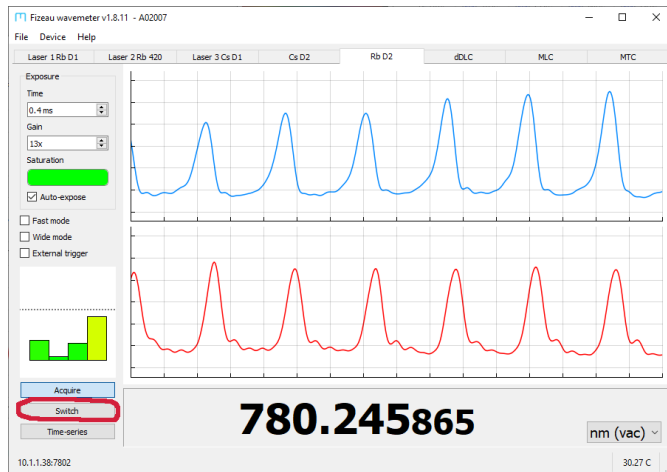

**Figure 3.5:** With FSW connected, the PID button is removed and a Switch button added, to open a new window for monitoring and controlling the switch channels.



# 4. Operation

## 4.1 Fringe identification and optimisation

The host software includes a prominent display of the interference fringes used to compute the laser wavelength. Understanding the fringe structure is important in ensuring that the wavelength measurement is accurate. The two primary causes of reduced measurement reliability are laser multi-moding, and poor spatial profile of the light emitted by the fibre.

The presence of multiple frequency components during a measurement can change the structure of the interference pattern and cause the measurement to fail. Typically this is evident by the presence of secondary peaks in the fringes, a significant widening of the peak widths, and/or a significant reduction in the amplitude of the fringes compared to the background level (Figure 4.1). Multimode behaviour may be evident in only one of the etalons (Figure 4.2) so it is important to periodically verify the fringe shape.

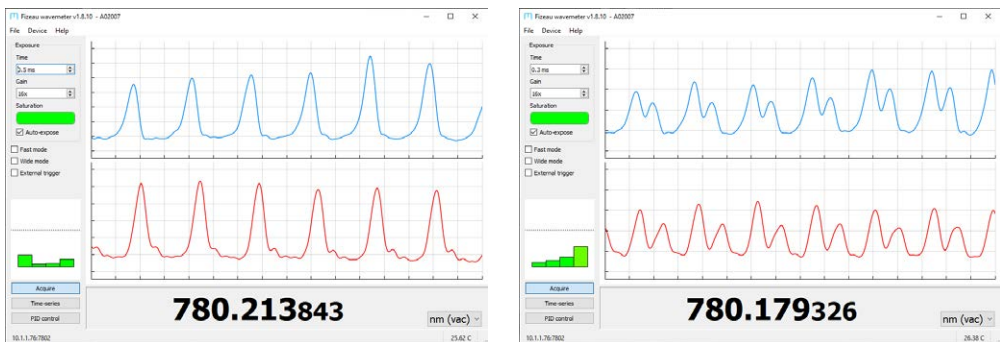

**Figure 4.1:** Examples of fringes measured with a single-mode laser (left) and multimode laser (right). The presence of secondary peaks and reduction in contrast indicate the laser is not single-mode.

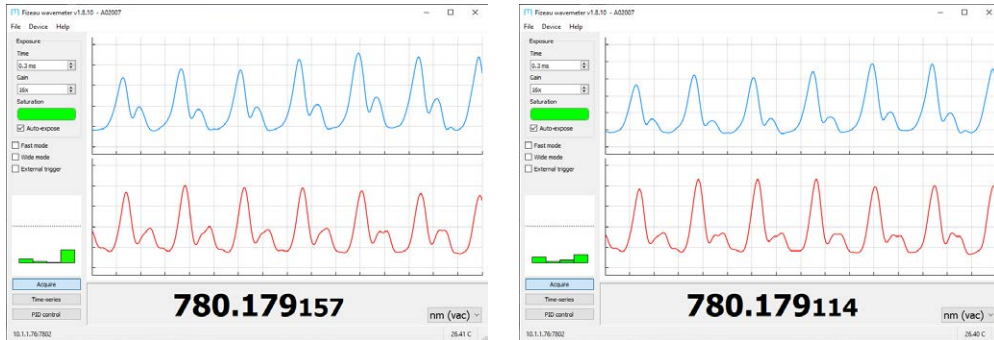

**Figure 4.2:** A multimoding laser might only be evident in one of the interference patterns. In some circumstances this will be clear from an obvious change in fringe spacing (left), whereas at other times the secondary peaks might be smaller amplitude (right).

Note that while the wavemeter may be able to produce a value for the wavelength of the strongest frequency component of a multimoding laser, the accuracy of this value should not be relied upon.

In many situations, multi-mode optical fibres are convenient for achieving good coupling efficiency quickly. However, they produce a non-Gaussian beam shape that introduces bias and reduces accuracy of the measurement. Single-mode fibres are therefore strongly preferable where accurate measurements are required.

With multimode fibre, the structure of the fringes fluctuates with both the fibre-coupling alignment and mechanical strain on the fibre, as can be seen by fluctuations in the measured wavelength when disturbing the fibre. Wherever possible the fibre should be restrained to the table and the coupling alignment should be optimised to make the peaks as close to equal height as possible (Figure 4.3).

Fibres with very large core diameters (e.g.  $>100\ \mu\text{m}$ ) should be avoided as the increased core size causes distortion in the interference fringes to the point where interpretation of the fringes becomes impossible (Figure 4.4).

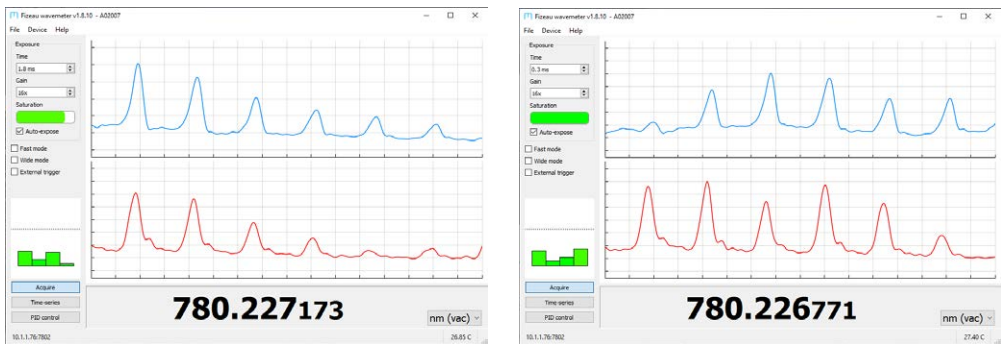

Figure 4.3: Example fringes measured with a 62.5  $\mu\text{m}$ -core fibre demonstrating envelope structure that causes measurement bias (left). Adjusting the input coupler alignment can give more uniform fringe heights (right) and more reliable measurement.

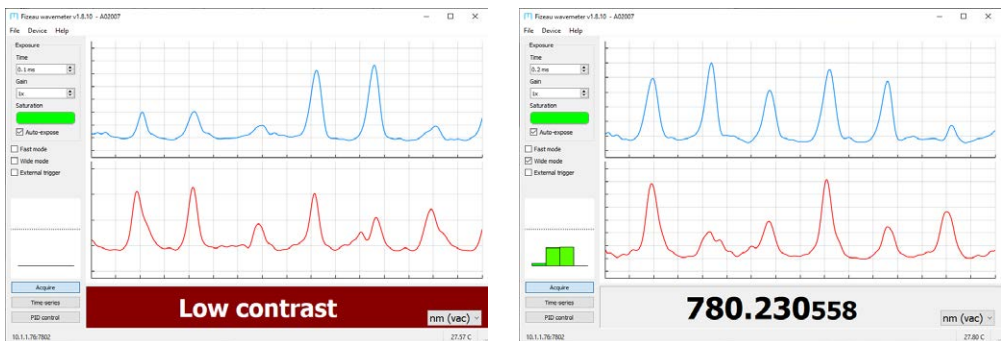

Figure 4.4: Examples of fringes measured with a 200  $\mu\text{m}$ -core fibre. The mode shape makes reliable readout almost impossible (left) although in some situations a low-accuracy measurement can be acquired (right).

In this scenario the unmeasurable etalons are ignored, and it may still be possible to extract a wavelength estimate with vastly reduced accuracy ( $\sim 20$  GHz uncertainty). In some applications this estimate may be sufficient, but smaller core fibres are strongly recommended.

## 4.2 Auto-exposure algorithm

The FZW has an auto-exposure algorithm that rapidly adjusts the exposure time to match the intensity of the incident beam to prevent over- or under-saturation. The algorithm is generally stable, but assumes small fluctuation in the input optical power. In situations where the optical power is not constant (such as with pulsed lasers, or ramping lasers with a large bias current) it may be necessary to disable the auto-expose feature.

## 4.3 Reducing noise

The auto-exposure algorithm attempts to maximise the rate of measurement by increasing electronic gain and reducing the exposure time. Increasing the gain also increases the measurement noise which increases the variance in the wavelength measurement. To reduce the wavelength measurement uncertainty, disable auto-exposure and reduce the gain. Adjust the input optical power to reduce the exposure time if necessary. Measurement averaging can also be used; see section 4.6 below.

## 4.4 Wide and fast modes

The default measurement mode is suitable for most applications and provides a good general-purpose trade-off between measurement speed and accuracy. In some situations it may be preferable to accept reduced accuracy to increase the measurement rate from the typical 150/s to over 300/s or to work with lasers with broad linewidth.

Engaging *fast mode* causes the wavemeter to read only two etalons, which increases the measurement rate but can miss sudden perturbations such as laser mode-hops. To minimise incorrect readings in fast mode, the FZW will re-measure all etalons periodically. Auto-exposure is disabled, hence drift in laser power can lead to errors. If the measurements seem unusual, disable fast mode occasionally.

In *wide mode*, the wavemeter reads only three etalons, ignoring the longest high-precision etalon. The measurement may be in error by several GHz but reliability can improve for unstable, pulsed, or high linewidth lasers which might otherwise result in *low contrast* errors.

## 4.5 Pulsed lasers

In normal operation, the FZW continually acquires images of the Fizeau interference pattern. External triggering can be used to ensure the exposure occurs when the laser pulse arrives.

### 4.5.1 Externally triggered mode

The TRIG 3.3V TTL input allows external triggering of measurements. External trigger must be enabled via the checkbox on `mogfzw`, or with the `meas,extrig` command (section B.4). By default, the TRIG input is active-low and the TRIG input should be high (+3.3V) between exposures. The FZW begins a measurement when the TTL input transitions to low. Holding the input low will immediately trigger a second measurement once the first is complete.

The polarity can be reversed to active-high using the command `meas,extrig,high`.

When external hardware trigger is enabled, a measurement can also be software-triggered using the `meas,softtrig` command. For pulsed lasers, the global shutter mode should also be enabled (see below).

External trigger mode is persistent across power-cycles.

### 4.5.2 Global and rolling shutter modes

The camera sensor has an electronic rolling shutter. Each pixel is subjected to the laser for an identical exposure time, but each row is exposed at a different time during the frame readout. When operating with pulsed lasers there is the possibility that the pulse occurs while a row is being read out, causing exposure of some pixels and not others.

For pulsed lasers, use the `meas,pulse` command (appendix B) to change the camera to a global shutter configuration, where all rows start exposure simultaneously. The exposure time is different for each row, with rows at the bottom of the frame exposed for longer. Global shutter mode is not recommended for CW lasers as it causes distortion from over-exposure towards the bottom of the imaging sensor.

Activating global shutter mode will freeze acquisition unless external trigger mode is active. Pulse-mode is persistent across power-cycles.

## 4.6 Measurement averaging

The FZW is capable of several hundred wavelength measurements per second, which can provide valuable realtime feedback when tuning lasers. Alternatively, these measurements can be automatically averaged to produce higher precision measurements at a slower rate. See §4.3 above on using lower gain to reduce noise.

The Allan deviation is a useful measure of the improvement achieved by increased averaging, as the influence of measurement noise is reduced but the influence of drift increases. An Allan deviation measurement (Figure 4.5) shows that the measurement precision can be improved by averaging for up to around 10 s.

For increasing time (Figure 4.6) the uncertainty grows, depending on environmental changes in temperature and pressure.

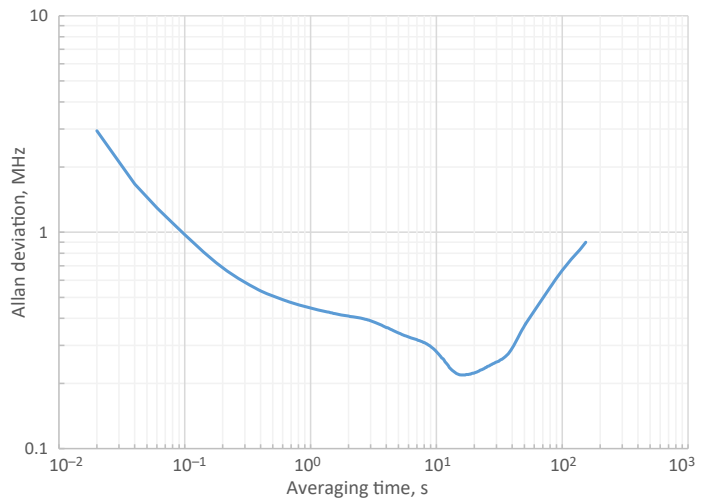

**Figure 4.5:** Measurement of the modified Allan deviation of the FZW measuring a locked laser, demonstrating that substantially improved precision can be achieved with averaging.

Averaging can be enabled through the on-device menu system, or using the `MEAS, AVERAGE` command. Setting the value to zero disables the internal averaging. Averaging can also be enabled in the time-series window of `mogfzw`, over the inspecified interval.

Operation of the FZW in environments with poor ambient temperature control can cause much more rapid drift, and the benefit of data averaging will be reduced.

## 4.7 Calibration adjustment

The FZW operates over a very wide range of wavelengths (400–1100 nm) and its absolute accuracy over this range is limited by a variety of broadband effects. The FZW does not include an internal calibration source because the inherent stability of the FZW across the full wavelength range is better than the accuracy of compact references such as a neon lamp.

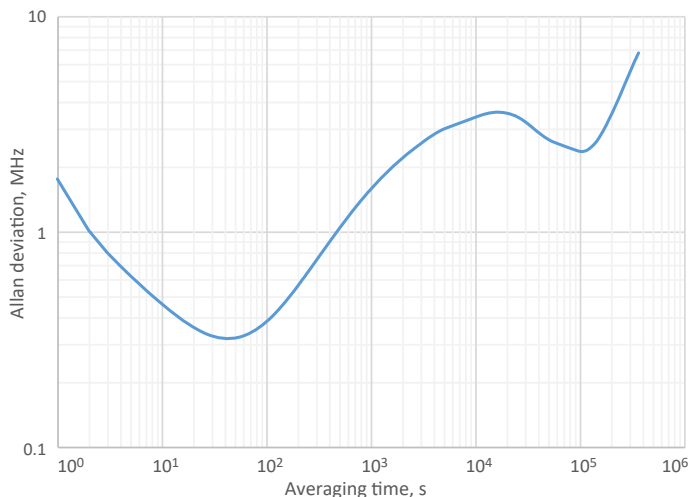
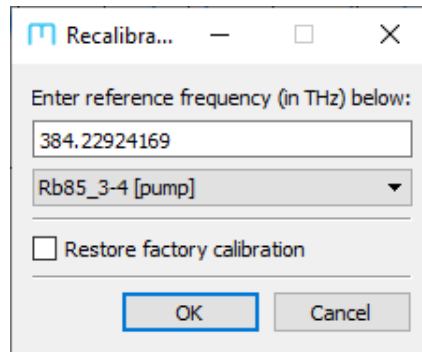

**Figure 4.6:** For longer times, the Allan deviation increases, in this case showing a dip at around one day, related to variations in the lab temperature.

However, often the accuracy of a wavemeter is only critical around a particular wavelength of interest, and it is desirable to improve the calibration of the device around this wavelength, even though this negatively impacts the absolute accuracy at other wavelengths.

To calibrate at a single wavelength, connect a reference laser of stable wavelength to the FZW using a single-mode fibre. The reference laser wavelength must be known to at the least the precision required from calibration. Then access the recalibration function through the “Device” menu of the host software (Figure 4.7) and enter the known laser frequency in THz. This calibration correction can also be applied programmatically using the `MEAS,CORRECT` command.

Note that when adjusting the calibration, it is recommended to use a well-known reference (e.g. atomic transition) with an appropriate amount of averaging.



**Figure 4.7:** The recalibration window of the host software allows correction of the device calibration using a known reference. A standard reference can be selected from the dropdown box, or a custom reference frequency can be entered.

The calibration can also be reverted to the factory-provided calibration by ticking the appropriate box in the software interface, or using the command `MEAS,CORRECT,RESET`.



# 5. PID locking

The FZW can output an analogue signal on the SMA connector ( $V_{\text{out}} = -2.5$  to  $+2.5$  V). That signal can be a fixed value or a PID control signal that attempts to drive the wavelength of a laser towards a set wavelength.

The FZW implements servo feedback control via a standard PID (proportional integral differential) function:

$$V(t) = Gk_p e(t) + Gk_i \int_0^t e(\tau) d\tau + Gk_d \frac{de}{dt} + V_{\text{offset}}$$

where  $V(t)$  is the feedback response, limited to  $[-2.5 \dots +2.5]$  V. The error is calculated as  $e(t) = (\lambda - \lambda_0)$  where  $\lambda, \lambda_0$  are the most recent wavelength and setpoint wavelength.  $G$  is an overall gain, and  $V_{\text{offset}}$  is a constant voltage offset. The PID coefficients  $k_p, k_i, k_d$  are floating-point values in the range  $[0, 1]$  which correspond to proportional, integral and differential terms respectively. Typical values are  $G = 10$  V/THz,  $k_p = 0$ ,  $k_i = 1$  and  $k_d = 0$ . The offset allows the FZW to control unipolar devices such as the MOGLabs DLC controllers which have 0 to 2.5 volt control input range.

When optimising a PID control loop, it should be kept in mind that the achievable loop bandwidth is limited by the propagation delay of the entire signal processing chain, including the measurement time, which depends on exposure time, and any delays in the laser response. A locking bandwidth of 10 Hz is feasible.

## 5.1 Using with MOGLabs DLC laser controller

If using the FZW with a MOGLabs laser and DLC controller, connect the FZW SMA output to the DLC SWEEP input and set DIP 9 on (external piezo stack control); see figure below. Set the offset to 1.25 V. Use the DLC SPAN knob as a master gain on the PID feedback. The SCAN/LOCK and fast lock should be off (up); only slow (piezo) feedback will be active through the SWEEP control.

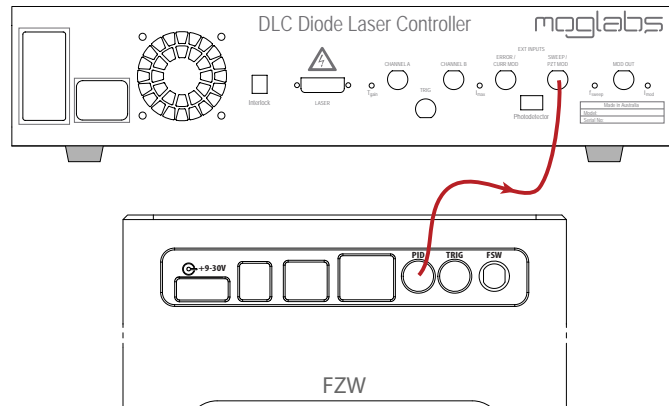

**Figure 5.1:** Stabilising a laser frequency with the FZW and PID. The SMA output of the FZW should be connected to the SWEEP/PZT input on the rear of the MOGLabs DLC controller.

## 5.2 PID parameters

The PID feedback signal is calculated on the device, but the parameters are most easily controlled using `mogfzw` while watching a plot of the wavelength against time using the time-series window.

**Setpoint  $\lambda_0$**  Defines the reference wavelength  $\lambda_0$ , for the the currently active *measurement* wavelength units set in the main `mogfzw` window or on the device.

**Gain (V/GHz)** Defines the gain,  $G$  in volts per GHz. The value should be ap-

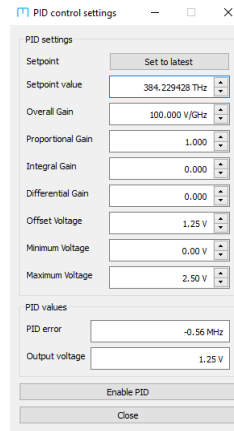

**Figure 5.2:** Interactive window for adjusting the PID constants, including display of the instantaneous PID error value (in MHz) and the output value (in Volts) for diagnostic purposes.

proximately the inverse of the frequency response of the laser and controller. For example, for a MOGLabs laser and DLC controller, the laser frequency response is about 10 GHz per volt swing on the SWEEP input, corresponding to a gain of 0.1 V/GHz. A negative gain can be used to invert the sign of the output voltage.

- $k_p, k_i, k_d$**  Proportional, integral and differential coefficients, each limited to a range of 0 to 1. Set  $k_i = k_d = 0$  to use the analogue output as a measure of laser wavelength, where  $k_p$  and the gain  $G$  define the relationship between the output voltage and the measured wavelength relative to the setpoint wavelength  $\lambda_0$ .
- $V_{\max}, V_{\min}$**  These set the upper and lower output voltage limits, and also the integrator windup limits. See section below regarding windup.
- $V_{\text{offset}}$**  The offset voltage; that is, the output when the laser is at the correct wavelength,  $\lambda = \lambda_0$ . For MOGLabs DLC controllers, set  $V_{\text{offset}} = 1.25$ .

### 5.2.1 PID commands

The PID gains can also be set using `PID,KP` and similar commands as in the example script below.

```
# define the desired lock point (in THz)
PID,SET,384.22924169
# set the gain to 10 V/GHz
PID,GAIN,10
# define the PID gains
PID,KP,0
PID,KI,1
PID,KD,0
# set the output range to be 0 to 2.5V centred at 1.25V
PID,MIN,0
PID,MAX,2.5
PID,OFFSET,1.25
# activate the PID
PID,ENABLE
```

Listing 5.1: Example script to configure the PID controller

The front-panel interface includes a multi-colour LED which indicates the status of the lock at a glance. The indicator is green when the lock is stable, yellow when the lock is engaged but the error signal has not converged to zero, and red when the output has saturated indicating the lock has failed (see also §2.1).

### 5.3 Integrator windup

Integrator windup is caused by saturation of an output actuator. Once the FZW output voltage reaches the maximum (or minimum) value defined by  $V_{\max}$  or  $V_{\min}$ , the integrator will continue to accumulate error (“wind up”), but the actuator is not able to respond to an increased control voltage. For example, on MOGLabs DLC controllers, the piezo control voltage is limited to 0 to 2.5V range and output voltages exceeding that range will not have any additional effect. If the actuator (laser) finally returns to within range, the “wound up” integrator has to reset from a value far from where it should be for the existing actuator value. That recovery can introduce a

long time lag in the response, or prevent the servo controller from ever reaching stable equilibrium. The solution is to stop integrating when the integrator reaches the saturation limit. For MOGLabs DLC controllers, set  $V_{\max} = 2.5$ ,  $V_{\min} = 0$ .

## 5.4 Examples

### 5.4.1 Analogue output of wavelength

With  $k_p = 1$  and  $k_i = k_d = 0$ , the SMA output voltage will be directly proportional to the measured wavelength relative to the setpoint. Figure 5.3 shows an oscilloscope trace of  $V_{\text{out}}$  for an FZW measuring the wavelength of a rapidly scanning laser, for example to optimise the laser mode-hop-free tuning range.

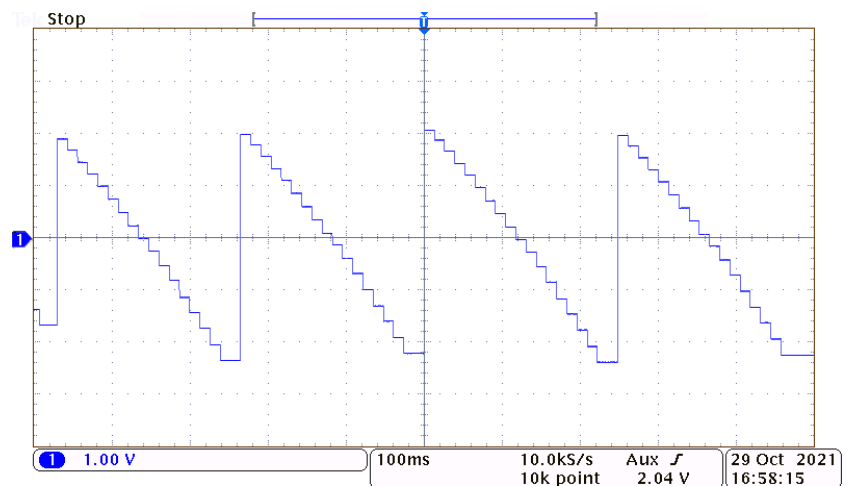

**Figure 5.3:** Wavelength measurement of a scanning laser. The gain was set to 0.5V/GHz and the ramp amplitude shows that the laser was scanning 9GHz. Note that the discrete steps are due to the measurement time, about 15ms per sample, not digitisation of the DAC.

## 5.4.2 Wavelength stabilisation

To control the laser wavelength, the output signal should be connected to the frequency control input of the laser, usually a piezo control, as in figure 5.1. Set the laser close to the desired wavelength, and click on *Enable PID*. The SPAN control on the DLC provides an adjustment of the overall gain. Initially, adjust the SPAN to a low setting and increase once the laser locks. If the laser frequency oscillates, reduce the PID gain (either the overall gain  $G$  or the relevant  $k_p$ ,  $k_i$  and  $k_d$ ).

The SPAN control can be used to maximise the effective resolution. For example, if the expected drift in the laser will be much less than the 0 to 2.5 V swing (20 GHz), a higher PID Gain setting can be used with reduced gain via the SPAN control. The net feedback gain will be the same but more of the DAC output range will be used.

The figures below show the locking response for a 780 nm MOGLabs cateye laser connected to a MOGLabs DLC controller. The PID settings are an overall gain of 0.5 V/GHz,  $k_p = k_d = 0$  and integrator coefficient  $k_i = 1$ . Note that  $k_p = 0$  because the wavemeter *measurement* fluctuates within a few MHz, even if the laser frequency is completely stable. That fluctuation would drive fluctuations in the laser frequency if  $k_p$  was non-zero. Similarly differential feedback ( $k_d$ ) is typically not helpful. Integrator feedback ( $k_i > 0$ ) averages the measurement fluctuations and drives the laser frequency close to the setpoint.

The time-series plot below shows the variance in the *measured* laser frequency when locked. The value fluctuates over a 10 MHz range. The DAC output, and the actual laser frequency, are much more stable due to the averaging effect of the integrator.

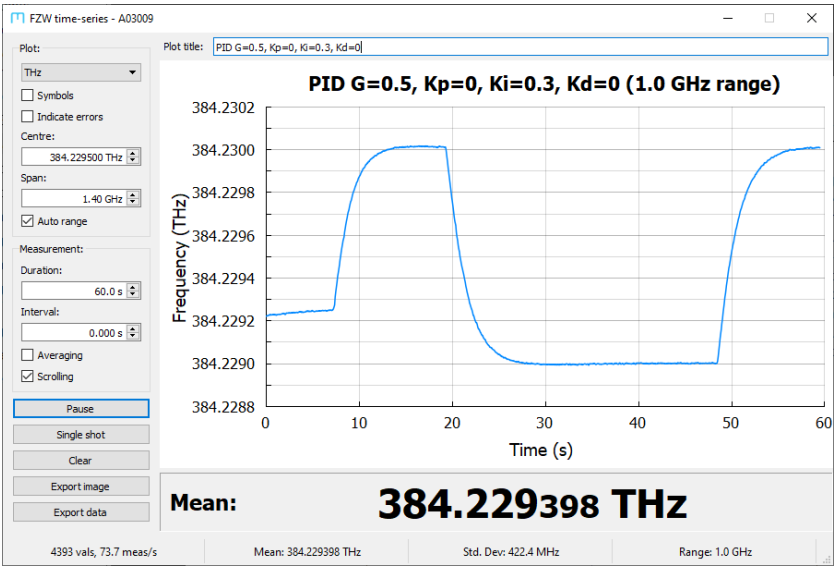

Figure 5.4: Time series measurement of the wavelength when PID is enabled at 8s. The setpoint is changed at 20s and again at 48s.

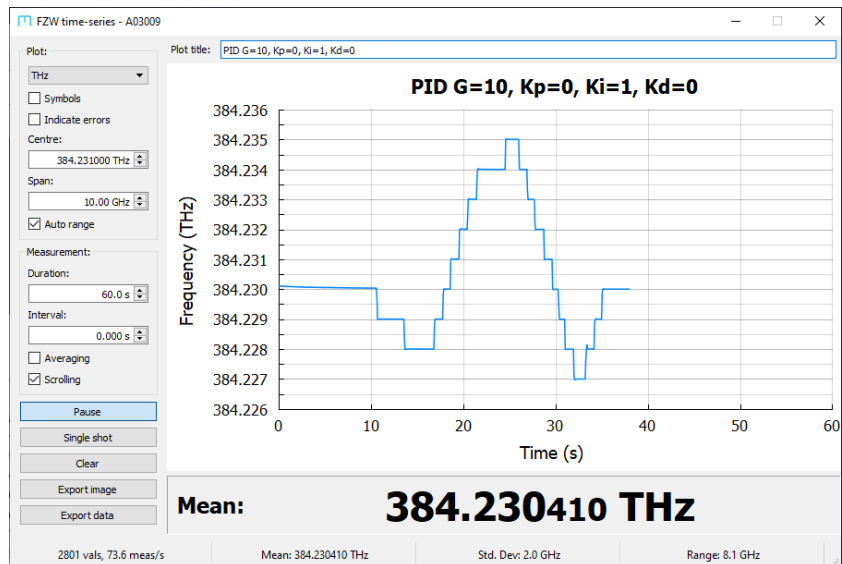
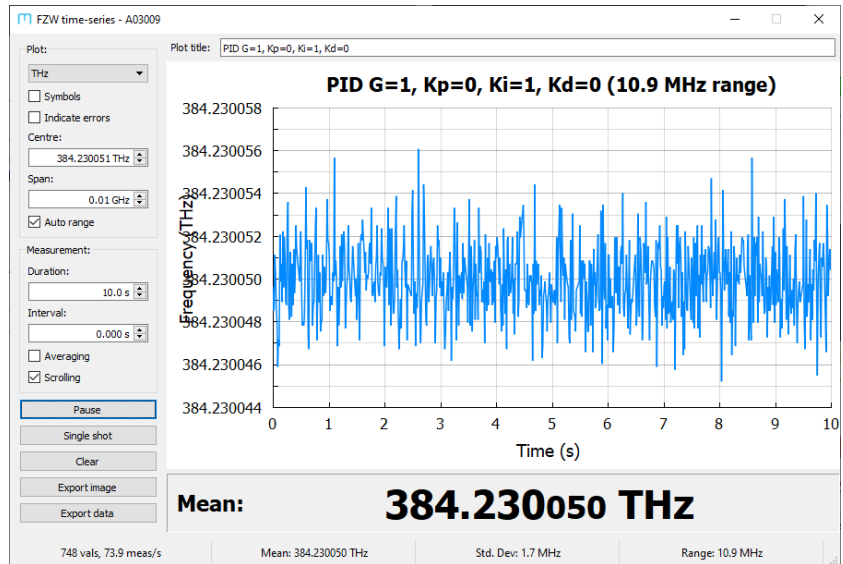

Figure 5.5: The  $G$  gain has been increased to 10 V/GHz, leading to much faster tracking of changes to the setpoint at each of the steps.



**Figure 5.6:** Fluctuations in the measured laser frequency when locked. These fluctuations are at the limit of the measurement of the position of the longest etalon fringes: a few MHz in a fringe spacing of 7500 MHz.



# 6. Optical switch

## 6.1 Overview

To enable measurement and control of multiple lasers, the FZW can integrate with several types of optical multiplexor (switch), particularly the MOGLabs FSM2, FSW4 and FSW8 2, 4 and 8-channel devices. The FSW provide digitally controlled output signals for each channel to enable active frequency stabilisation. Other simple two-channel TTL-controlled switches can also be used (see §6.2 below). An M8 connector on the rear of the FZW (see §F.1) provides power and control signals to the switch.

## 6.2 2x1 switch modules

The FZW can be provided with an internal or external 2x1 switch module, or used with industry-standard 2x1 switch modules such as the Thorlabs OSW12 series, where the port is selected by a single TTL control signal. The rear-panel M8 switch connector will provide +5V and a TTL-compatible port selection output; see §F.1.

The FZW must be manually configured to drive these devices using the `OPTSW,2x1` command. The port can then be changed using the same commands used for the FSW devices, and `mogfzw` will assume there is a 2-channel switch attached and allow selection of either port. To revert back to FSW switches, use the `OPTSW,FSW` command.

## 6.3 MOGLabs FSW fibre switches

The FZW can control one or more MOGLabs FSW units, each with 4 or 8 input channels. The FSW use high-speed MEMS-based switch modules with integrated microcontroller. The FZW will auto-detect the switch and number of channels, and the `mogfzw` host software will then allow selection of the channel (see below).

The front and rear panels of the original (Rev1) and updated (Rev2) designs for the FSW are shown below in Figure 6.2.

The switch can be controlled through software commands or with the physical push-buttons on the FSW devices. LEDs on the front indicate the active channel, and separate SMA outputs on the back provide individually-configurable PID outputs for each channel.

The switch has connectors to receive a number of FC/APC input fibres, and a single FC/APC output fibre for connection to the FZW. It has indents on the top surface that align with the feet of the FZW, so the two can be carried together as a single unit. Care should be taken to ensure the output fibre is not accidentally sheared.

### 6.3.1 Operation

The FSW4 and FSW8 contain a MEMS (micro electro-mechanical system) mirror module that optically couples one of the 4 or 8 input fibres to a single output fibre. The MEMS module has infinite lifetime, with typical switching time of 5 ms (10 ms max), and insertion loss below 2 dB for 600 nm wavelength. The input power should be limited to 100 mW, and preferably below the 10 mW maximum input power of the FZW.



**Figure 6.1:** FSW4 (left) beside an FZW. Normally the FZW would sit on top of the FSW to provide a very compact combination.

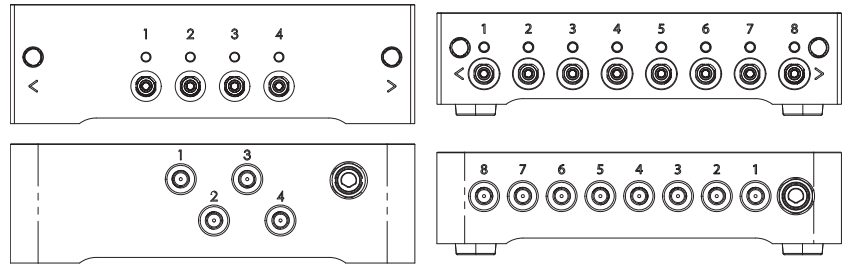

**Figure 6.2:** FSW4 (left) and FSW8 (right) optical switches. The front-panels (top) have fibre inputs and LED indicators, while the back-panels (bottom) have SMA outputs for monitoring and PID control. The front-panel buttons cycle between the input fibres.

### 6.3.2 Optical bands

Each input port can be optimised for a different wavelength band. There are four optical bands numbered from 0 to 3. Bands 0, 1 and 2 are factory optimised using lasers in the blue (400 nm), red (600 nm) and infra-red (1100 nm).

The normal configuration is as shown in the table below. Band 3 can

| Band | Wavelength | Range         |
|------|------------|---------------|
| 0    | 400 nm     | 400 – 600 nm  |
| 1    | 600 nm     | 500 – 900 nm  |
| 2    | 1100 nm    | 800 – 1100 nm |
| 3    | Selected   |               |

be configured on a port-by-port basis, using the values from band 0, or 1, or 2. The band can be selected through the `mogfzw` FSW Switch control (see section 3 below), or using commands detailed in appendix B.

For example port 1 could be optimised for blue light, port 2 for middle wavelengths, and ports 3 and 4 for longer wavelengths. The commands would then be as follows:

`OPTSW,copy,1,0` copy port 1, band 0 to band 3 for blue  
`OPTSW,copy,2,1` copy port 2, band 1 to band 3 for red  
`OPTSW,copy,3,2` copy port 3, band 2 to band 3 for longer wavelengths  
`OPTSW,copy,4,2` copy port 4, band 2 to band 3 for longer wavelengths  
`OPTSW,band,3` select band 3  
`OPTSW,dband,3` select default band 3  
`OPTSW,set,1` select input on port 1.

The settings are remembered after power cycling so they need only be set once. The default band used on power up is set with the `OPTSW,dband` command.

The insertion loss is wavelength-dependent, varying from 2 or 3 dB for band 1 and wavelengths around 600 to 700 nm, to 10 or 15 dB at 400 or 1100 nm, even with the optical band optimisation.

### 6.3.3 mogfsw optimiser

`mogfsw` is a tool for minimising insertion losses through the FSW for any specific wavelength. For example, to reduce insertion losses at 852 nm, the laser can be fibre-coupled to, say, port 2, and then the mirror deflections for port 2 can be adjusted until the output is maximum. The settings would be saved to one of the three bands, for example the 600 nm band. Then the band for that port should be set to the 600 nm band (see below) so that whenever port 2 is selected, the new optimum mirror settings will be used. `mogfsw` can be found on the MOGLabs support website for the FZW wavemeter. Detailed instructions are provided through the `Help` menu.

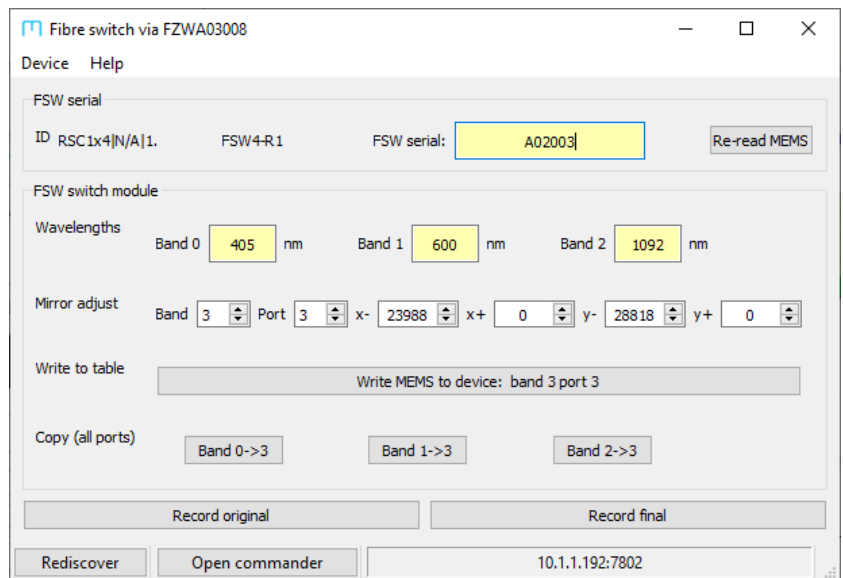
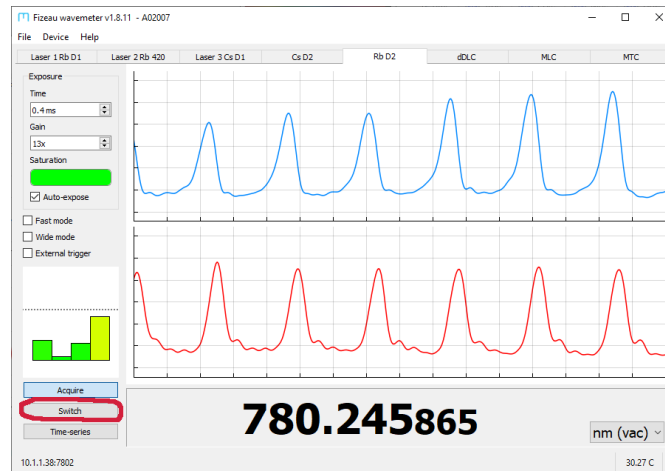

Figure 6.3: mogfsw allows adjustment of the MEMS mirrors to optimise throughput for a given wavelength for each fibre input port.

## 6.4 mogfzw switch UI

When connecting to an FZW that has an FSW optical switch attached, the interface will show a tabbed view for the different switch inputs. Names can be assigned to the inputs by double-clicking each tab.

When an FSW is connected, the PID button in `mogfzw` will be replaced with a `Switch` button (fig. 6.4). The FSW switch control

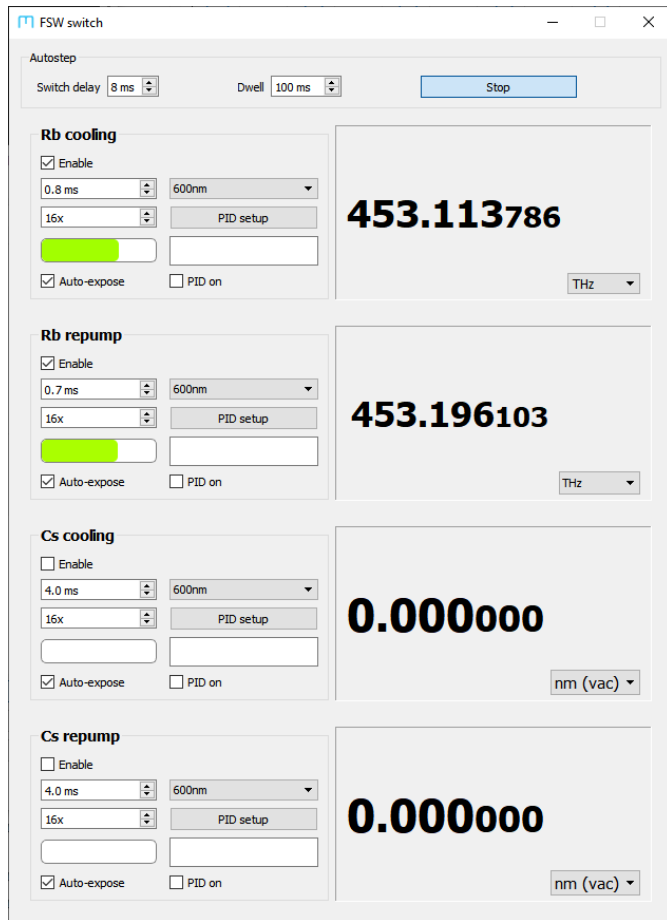

**Figure 6.4:** With FSW connected, the PID button is removed and a Switch button added, to open a new window for monitoring and controlling the switch channels.

window shows the wavelength measurement, exposure, and optical band setting for all channels simultaneously. Each port can be configured, for example to select the optical band, or to control the PID parameters. The figure below (fig. 6.5) shows the `Switch` tool for a 4-port switch.

**Port name** Double-click within the settings area for any port, to allow entry of a name for that channel.

**Enable** When auto-stepping through the ports (see below), only those with `Enable` checked will be measured; others will be skipped. Disable



**Figure 6.5:** The FSW switch window shows the wavelength for all input channels, and allows control of exposure, optical band and PID parameters for each.

any dark ports, otherwise the auto-expose algorithm can cause long delays whenever a dark port is selected.

**Exposure** The exposure time is displayed. The value can be manually adjusted if Auto-expose is unchecked. The exposure time will be automatically reduced to less than the dwell time, if auto-stepping.

- Gain** The analogue camera gain is displayed and can be manually adjusted if Auto-expose is unchecked.
- Optical band** The optical band for each port is shown in a drop-down list of allowed bands. The band can be changed to achieve the shortest exposure time, and will be remembered by the device.
- PID setup** Select to open the PID control dialogue for the associated port. See chapter 5 for more details on PID control.
- PID on** Allows convenient enable/disable of PID feedback for the associated channel. The output voltage will be shown in the box above, with colour-coded background to indicate saturation. The colour will be green when the output is near the zero-point offset, and will become more red as the output voltage approaches either the minimum or the maximum voltage as specified within the PID control dialogue.
- Units** The units can be individually selected for each channel by double-clicking in the wavelength display box or using the associated drop-down units selector.

### 6.4.1 Automatic sequencing

The switch channel can be auto-incremented using the Autostep feature, with fixed measurement time at each channel. Two parameters can be controlled: the switching delay and the dwell time for each port.

**Note** It is important to deselect any dark ports by un-checking the `Enable` box.

Press `Start` to begin auto-stepping and again to stop. Auto-stepping will be stopped if the `FSW switch` dialogue is closed.

**Switch delay** Should be set to the time required to change the switch, which is the sum of the physical switch time and the time to communicate with the optical module. For FSW switches, the delay value is typically 8 to 10 ms, and for 2x1 switches, up to 25 ms. If set too short, initial measurements after a port-change will be unstable.

**Dwell** The time to measure each port before stepping to the next. Should be set longer than the switch delay plus the time for two full exposures. The FZW will make at least one measurement before stepping, and thus the dwell can be set to 1 ms for maximum step rate, but will not wait longer than the sum of the switch delay and two exposure times.

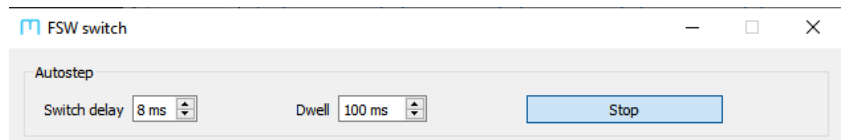

Figure 6.6: Control of auto-stepping via the `FSW switch` control window.

### 6.4.2 Simultaneous PID

Multi-channel PID feedback becomes possible with auto-stepping enabled. The control signal for each channel will be updated when the sequence returns to that channel, and will remain constant when different channels are being measured.

To configure multi-channel PID feedback:

1. Deselect any dark ports.
2. Before trying to PID lock a laser, make sure it has a good mode-hop-free range around the desired wavelength/frequency.
3. Configure each laser/port in turn as described in chapter 5. Disable PID locking for each before setting up the next. Note that when `PID setup` is pressed for a given port, the switch will select that port and stop auto-stepping to provide the best response times for adjusting the PID parameters.

The time-series window is very useful to monitor the wavelength while configuring the PID locking parameters, provided auto-stepping is not enabled.

4. When all ports/lasers are locking individually, with PID feedback off for each, start auto-stepping. The exposure time should be short compared to the dwell time; for example, 1 ms exposure and 100 ms dwell time.
5. Enable PID for each laser in turn, making sure the laser adjusts to the correct wavelength before enabling the next.

## 6.5 Drift correction

Drift in the FZW measurement can be continually and automatically corrected by reference to a stabilised reference laser on one of the fibre switch ports (see fig. 6.7). With a reference channel selected and drift correction enabled, variation in the measured laser frequency on that channel will be assumed due to drift in the FZW.

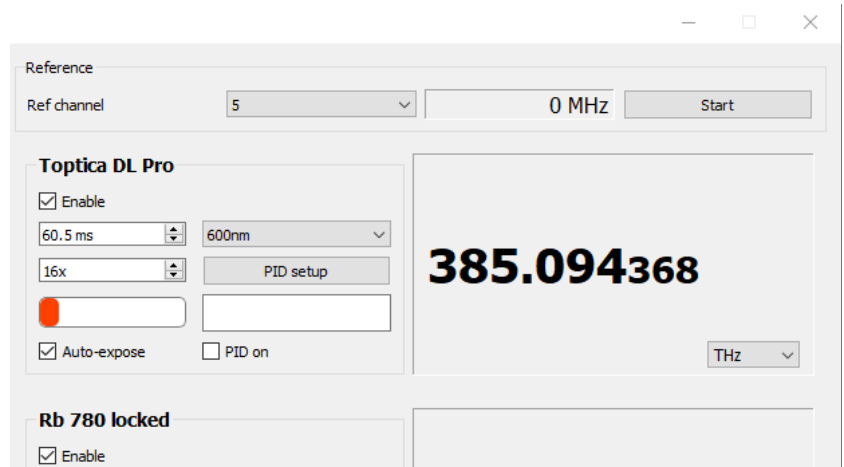
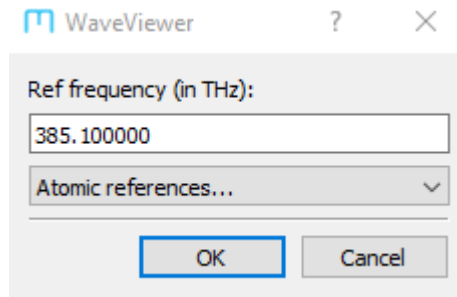

**Figure 6.7:** Reference channel selection for drift correction, with current calculated drift correction (in MHz).

Those changes will be subtracted from the measured frequency for all channels (using the FZW device `MEAS,SHIFT,va1` command).

When drift correction is started, a dialog opens allowing entry of a known frequency for the reference laser (see fig. 6.8). A frequency can be entered (in MHz), or selected from a drop-down list of known atomic references. Enter a value of zero (0) to use an average of the first 25 measurements as the reference. The difference relative to the initial reference is calculated and subtracted from future measurements. The displayed wavelengths for all channels will in principle be corrected for the FZW drift, and PID locking will also be corrected.

The correction is re-started (that is, a new initial reference is determined from 25 measurements) when the reference channel is changed, or when drift correction is stopped and re-started.



**Figure 6.8:** Dialogue to specify the exact frequency of the reference laser (in MHz). Select from the atomic references, or enter a frequency in MHz. Enter zero to use the average of the first 25 measurements as the reference.

## 6.6 Multiple FSW

The FZW controls the FSW switches using the I<sup>2</sup>C communication protocol. Multiple FSW units can be connected to one FZW using parallel cable connections; that is, the power, clock and data lines (see figure F.4) should be connected to each unit. Each FSW must have a different I<sup>2</sup>C address. Please contact MOGLabs for instructions if needed.

# A. Specifications

| Parameter | Specification |
|-----------|---------------|
|-----------|---------------|

| Accuracy                           |   |
|------------------------------------|---|
| Measurement range                  | 350 – 1120 nm<br>Up to 1350 nm with 50 mW in fibre <sup>1</sup> |
| Absolute accuracy <sup>2</sup>     | <600 MHz (370 – 1120 nm)  |
| Measurement precision              | 10 MHz (full-speed),<br>1 MHz (100-sample average)              |
| Minimum optical power <sup>3</sup> | 10 $\mu$ W (300 meas/s),<br>100 nW (10 meas/s)                  |
| Maximum optical power              | 10 mW   |
| Exposure time                      | 100 $\mu$ s to 1 s  |
| Measurement rate                   | Up to 300 meas/s  |
| Number of etalons                  | 4   |
| Smallest etalon FSR                | 7.5 GHz   |

| Electronics         |  |
|---------------------|--|
| DC jack power input | +5 V (Rev 1–3) or 9–24 V (Rev4+),<br>as labelled on device                 |
| Power usage         | < 3 W  |
| Display             | Integrated colour LCD screen   |
| Analogue output     | 16 bit DAC output, $\pm 2.5$ V range<br>(12 bit on Rev 1–3, serial A02xxx) |

<sup>1</sup>5 s exposure.

<sup>2</sup>Absolute accuracy as measured in a temperature-stabilised laboratory environment using a spectrally-narrow laser coupled into single-mode fibre.

<sup>3</sup>Stated optical powers are indicative for 525 nm light; actual optical power limits scales with detector responsivity (Figure A.1).

| Parameter | Specification |
|-----------|---------------|
|-----------|---------------|

| Interface         |  |
|-------------------|--|
| Ethernet          | 10/100 RJ45  |
| USB               | USB2.0 device with USB-B plug  |
| Optical input     | FC/PC or FC/APC as labelled on device  |
| Control software  | Integrated on-device menu system<br>Windows™ software suite<br>Integrated web server |
| Language bindings | python, MATLAB, LabVIEW  |

| Mechanical |                           |
|------------|---------------------------|
| Dimensions | W×H×D = 146 × 120 × 81 mm |
| Weight     | 1.5 kg                    |

| Optical switch              |                           |
|-----------------------------|---------------------------|
| Wavelegth range             | 400 nm to 1120 nm         |
| Lifetime                    | > 20 billion cycles       |
| Connectors <sup>4</sup>     | FC/APC input and output   |
| Switching speed             | 5 ms (typ), 10 ms (max)   |
| Insertion loss <sup>5</sup> | < 2.0 dB                  |
| Return loss                 | 50 dB (min), 55 dB (typ)  |
| Max optical power           | 100 mW without damage     |
| Dimensions                  | W×D×H = 146 × 120 × 33 mm |

<sup>4</sup>Singlemode 630HP fibre, non-PM.

<sup>5</sup>Wavelength-dependent.

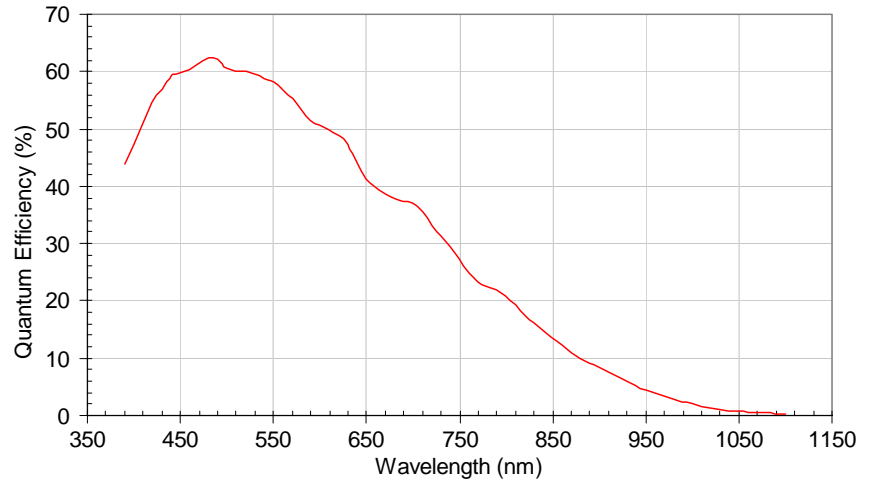

Figure A.1: Typical detector responsivity.

| Power ( $\mu\text{W}$ ) | 522 nm | 780 nm | 1095 nm |
|-------------------------|--------|--------|---------|
| 0.1                     | 120    | 580    |         |
| 1                       | 80     | 40     |         |
| 10                      | 0.8    | 5      | 120     |
| 100                     | 0.3    | 0.8    | 14      |
| 200                     |        | 0.4    | 2       |
| 300                     |        | 0.2    | 0.8     |

Table A.3: Exposure time (in milliseconds) for different wavelengths.



## B. Command language

The FZW can be controlled over USB via a virtual serial port, or over Ethernet using TCP/IP. The syntax follows a text-based request/reply architecture with messages delimited by CRLF. Failed queries are replied to with the string “ERR” followed by an explanation of the issue. It is strongly recommended to check for the response before sending the next command.

**Please note:** The command language is being continuously updated across firmware releases to improve functionality and add features. When upgrading firmware, please refer to the most recent version of the manual available at <http://www.moglabs.com>

Some commands accept values with units. The following units are recognised for returning measurements or defining setpoints:

- nmv, vac** Wavelength in vacuum, in nanometers.
- nma, air** Wavelength in air, in nanometers as measured within the interferometer. May differ from expected standard temperature and pressure (STP) value due to environmental conditions.
- THz** Frequency, in terahertz.
- wav, pcm** Wavenumber, in per centimetre.

### B.1 General functions

- INFO** Report identification information about the unit.
- TEMP** Report measured temperatures. Returns three values, for the interferometer, the sensor, and the microcontroller in that order.
- VER** Report versions of firmware currently running on device.  
Please ensure to include both the **INFO** and **VER** information in any correspondence with MOGLabs.

## B.2 Display

**CONTRAST** `DISP,CONTRAST[,val]`  
Sets the contrast of the display, which is either a percentage value, or an integer between 0 (off) and 15 (full brightness).

**SLEEP** `DISP,SLEEP[,val]`  
Sets the sleep timer of the display, which is the time in seconds after the last button press that the display is dimmed. Setting the timer to zero disables the dimmer behaviour.

## B.3 Measurement

**AVERAGE** `MEAS,AVERAGE[,val]`  
Specify the wavelength measurement to average over `val` milliseconds for improved measurement precision at the expense of measurement rate. `val` is limited to 60,000 (1 minute averaging time). If `val` is zero, no averaging is performed. If used with a fibre switcher, the averaging time can be different for each channel. Note: behaviour is unknown if used with auto-stepping of a fibre switcher.

**CLEAR** `MEAS,CLEAR`  
Reset the measurement averaging and internal verification, for use in combination with an external optical switch or shutter.

**CONTRAST** `MEAS,CONTRAST`  
Returns the measurement contrast, which is a number in the range [0, 100] that measures the fringe quality.

**CORRECT** `MEAS,CORRECT,val`  
Apply a correction to the device internal calibration using the currently-supplied laser as an absolute reference. The reference `val` should be specified *in THz* and as many significant figures as practical. Perturbing the calibration in this way will improve the absolute accuracy of the device around the reference wavelength, at the expense of the absolute accuracy far from the reference wavelength.

Specify `val` as the string `RESET` or `FACTORY` will revert the calibration to the factory-provided values.

**DF** `MEAS,DF`

Returns the convergence parameters for all etalons, as percentages.

**DUMP** `MEAS,DUMP`

The FZW keeps a circulating buffer of measurements. The `DUMP` command returns the buffer as a binary block, which can be particularly useful when the measurement rate is high, and when measuring rapidly changing wavelengths.

The block begins with the length of the measurement buffer, in bytes, as a 32-bit unsigned integer; that is, the number of measurements to be sent, multiplied by the length of each measurement (10 bytes). It then sends the actual measurements, where each measurement consists of:

**Time** 16-bit unsigned integer. Time stamp, milliseconds. Will wrap at 65.536 s.

**Wavelength** 32-bit unsigned integer. To convert to wavelength, multiply by  $1200.0/(2^{32} - 1)$ .

**Phase** Four 8-bit signed integers. Phases for the four fringe patterns.

The buffer wraps, so that if the buffer fills, the oldest measurements are over-written by newer data.

Note that binary values are little-endian, and the values are wavelengths in air as measured within the interferometer.

**IMG** `MEAS,IMG,etalon`

Return interference pattern for specified etalon. `etalon` is 0 to 3, where 3 is the longest etalon, usually 7.5 GHz free spectral range. The pattern is 512 bytes, unsigned integers.

**MODE** `MEAS,MODE[,val]`

Set or query the measurement mode. The mode can be selected with a letter (S, F or W) or integer (0..3):

- 0 Pause measurement, for acquiring sensor images.
- 1, S Standard. Uses all four etalons for maximum accuracy.
- 2, F Fast. Acquires only two etalons to double the measurement rate.
- 3, W Wide. For lasers with linewidth comparable to or larger than the FSR of the long etalon (7.5 GHz).

The fast mode is useful for monitoring laser scanning, but is subject to counting error such that the measurement might be incorrect by an integer multiple of the long etalon FSR (7.5 GHz). Fast mode cannot be enabled when auto-stepping a fibre switch.

**PH** MEAS, PH

Returns the fringe phases for all etalons (domain  $-0.5$  to  $+0.5$ ).

**REPORT** REPORT

Return detailed measurement report, for example:

```
WL: 778.269558702, P: 1002.37, T: 26.96, EXP: 4.68,  
GAIN: 126, SPORT: 6, PH: 0.13 0.15 0.13 -0.39,  
DF: 10.7 -5 15.7 7.3, SAT: 3790.6, CONTR: 69.27
```

where the parameters are wavelength (in air), pressure (mbar), temperature ( $^{\circ}\text{C}$ ), exposure (ms), camera gain, selected fibre port, fringe phases, convergence parameters, saturation and contrast.

**SAT** MEAS, SAT

Returns the measurement saturation, which is a number in the range  $[0, 100]$  that depends on the optical power reaching the detector. Typically the saturation should be around 30.

**SHIFT** MEAS, SHIFT, val

Apply a shift to the measured frequency. The shift `val` should be specified *in THz* with double precision. The device calibration coefficients are not affected. The shift value is volatile; that is, it will be zeroed on power cycle or device reset. This command will normally be used to correct for long-term drifts, using periodic measurement of a frequency stabilised reference laser; see section 6.5.

**STATE** `MEAS,STATE`

Return measurement state, either `ERR:` followed by an integer error code and descriptive string, or an integer that indicates the mode (1 = normal or 2 = fast).

Errors are:

- 1 Comms failure
- 2 Internal error
- 4 Math error
- 5 Multi-mode
- 6 Unstable mode
- 7 Over-exposed
- 8 Under-exposed
- 9 to -12 Low contrast

**UNITS** `MEAS,UNITS[,units]`

Set the default units for measurement readback, as well as the units used by the integrated LCD display.

**WAVELENGTH** `MEAS,WAVELENGTH[,units]`

`MEAS,WL[,units]`

`MEAS,FREQ`

Returns the most recently measured value of the wavelength, in the specified `units`.

## B.4 Camera

When used with an optical switch, the following camera settings apply to the currently selected port.

**AUTO** `CAM,AUTO[,val]`

Enable or disable the auto-exposure algorithm to dynamically adjust the exposure time to match the input (see §4.2). If specified, `val` should be ON or OFF.

**EXP** `CAM,EXP[,val]`

Set/query the camera exposure time to `val` milliseconds. If `val` is specified, the auto-exposure algorithm is disabled unless `val` is the string "AUTO".

**EXTRIG** `MEAS,EXTRIG[,val]`

Enable or disable the external trigger, SMA input TRIG, +3.3V TTL (see §4.5.1). `val` should be

**ON** or **1** to enable the external trigger

**OFF** or **0** to disable the external trigger

**HIGH** for active-high trigger

**LOW** for active-low trigger (default).

In default active-low mode, the TRIG input should be held high between exposures. The FZW begins a measurement whenever the TTL input transitions to low. The trigger is level-sensitive rather than edge-sensitive, so holding the input low will immediately trigger a second measurement once the first is complete.

If active-high, the TRIG input should be held low between exposures, and exposure will begin when the TTL input transitions high.

Note that the TRIG input has a 4k7 pull-up resistor to +3.3V.

Pulsed (global shutter) mode should also be activated, so that all regions of the sensor are active during the exposure.

**GAIN** `CAM,GAIN[,val]`

Set/query the camera analogue gain, which is an integer in the range [8, 126]. Increasing the gain allows the exposure time to be reduced for the same optical power, enabling an increased measurement rate. The effective increase in measured counts is `val` divided by 8. Also reports a value for digital gain which is not used in any way.

**PULSE** `MEAS,PULSE[,onoff]`

Enable or disable global shutter mode, for use with pulsed lasers (see §4.5). `onoff` should be ON or 1 to use global shutter, OFF or 0 for normal rolling shutter mode.

External trigger should be enabled. Activating global shutter mode without also enabling external trigger will freeze acquisitions.

**SOFTRIG** `MEAS,SOFTRIG`

Software trigger and exposure, when external trigger mode is enabled.

## B.5 Optical switch

The following commands apply if a valid optical switch is connected. If no switch is found, each will respond with an error message.

**2x1** `OPTSW,2x1`

Change switch type to simple two-channel (2x1) TTL-based device. See §F.1 for electrical connection specification.

**AUTO** `OPTSW,AUTOstep[,dwell]`

Enable or disable auto-stepping, and query or set the interval between stepping the channel. If `dwell` is given and non-zero, the FZW and FSW will automatically sequence through the fibre input ports, stepping every `dwell` milliseconds. Use zero `dwell` to disable auto-stepping. If `dwell` is not given, returns the current dwell time.

The actual interval for each channel will be the greater of the specified `dwell` and the sum of the `LAG` optical switching time and two times the exposure time for that channel. Thus for regular intervals, `dwell` should be greater than `LAG` plus twice the maximum expected exposure time across all channels.

The fastest switching time is around 30 ms, with `dwell` set less than `LAG` so that the channel will switch after one measurement, with the exposure 10 ms or greater.

Auto-stepping cannot be enabled if fast measurement mode is active.

Auto-expose requires several sequential measurements to work, and thus will fail if the switch steps too quickly. It is recommended to disable auto-expose on every channel before starting auto-step mode.

**BAND** `OPTSW,BAND[,int]`

Returns the current optical band, 0 to 3 (see section 6.3.2). To change the band, provide an integer (0 to 3) argument, for example

- OPTSW,BAND,3.** The selected band applies to all ports. Note that the MEMS mirror positions will not change to the new values until the input port is selected with an **OPTSW,set** command.
- COPY** **OPTSW,COPY,port,sourceband**  
Copy MEMS mirror positions from specified source band to band 3 for the given input port. **port** can be 1 to 4 or 1 to 8; **sourceband** should be 0, 1 or 2. See section 6.3.2 for more further explanation.
- DBAND** **OPTSW,DBAND[,int]**  
Report or set the default band; that is, the band that is selected when the device starts up. The selected band applies to all ports.
- EXP** **OPTSW,EXP[,val]**  
Report or set the exposure time in milliseconds for the selected channel. **val** is a floating-point number; specify **AUTO** to set auto exposure for the selected channel. If in auto-expose mode, query return current exposure time followed by **AUTO**, for example 0.32 ms **AUTO**.
- GAIN** **OPTSW,GAIN[,val]**  
Report or set the gain for the selected channel. **val** is an integer in the range [8, 126].
- FSW** **OPTSW,FSW[,n]**  
Change switch type to MOGLabs FSW four and eight channel device. Returns number of FSW units connected, or integer **n** (**n=1,2**) can be provided to switch between FSW units if multiple switch modules are connected.
- ID** **OPTSW,ID**  
Returns the ID string for the connected FSW.
- LAG** **OPTSW,LAG[,lag]**  
Query or set the switching time; that is, the time to wait after switching, before measuring wavelengths. The time is typically 8 to 10 ms, which includes the optical module switching time of 5 ms and time to communicate to the module. The maximum **lag** is 200 ms.

- POWER** `OPTSW,POW,off`  
`OPTSW,POW,on`  
Control power to the FSW switch. Cycling the power off and on can be used to reset communications to the device.
- REPORT** `OPTSW,REPORT,port`  
Return parameters for specified port, for example:  
    WL: 778.268978842, EXP: 4.68, AUTO: 1,  
    GAIN: 126, SAT: 36.8, CONTR: 0.70, SKIP: 0, PID: 0  
where the parameters are wavelength (in air), exposure (ms), auto-exposure (0 or 1), camera gain, saturation, contrast, skip (0 or 1), PID enable (0 or 1).
- RESET** `OPTSW,RESET`  
Hardware reset of the FSW.
- SELECT** `OPTSW,SElect[,port]`  
Query or set the port selected for reporting or setting port-related parameters such as exposure, gain, measured wavelength, saturation, contrast, and etalon lineouts, without changing the port being measured. When auto-stepping, the measuring port will automatically change, but the `SELECT` port will not change. The `OPTSW,SET,port` command changes both the measurement port and the `SELECT` port.
- SET** `OPTSW,SET[,port]`  
Query or set the measuring optical fibre input port. For example, `OPTSW,set,3` to select port 3. The `SELECT` port (see above) is also changed even if autostepping.
- SKIP** `OPTSW,SKIP,port[,val]`  
Query or set whether the port should be skipped when auto-stepping. `val` should be `0` or `off` to disable the specified port; `1` or `on` to enable the port. If no `val` is provided, will return existing state.
- TABLE** `OPTSW,TABLE, port`  
`OPTSW,TABLE, port, xneg, xpos, yneg, ypos`  
Read or write MEMS mirror positions to current band, for specified

port. `port` can be 1 to 4 or 1 to 8. The mirror positions can have values from 0 to 65535. One x and one y value must be zero.

**TOGGLE** `OPTSW,TOGGLE`

The `toggle` command changes the FZW/FSW communications protocol to that required for older 4x1 versions of the FSW.

**TYPE** `OPTSW,TYPE`

Returns string identifying the switch type, for example FSW4-R0 for a 4x1 switch, revision 0.

## B.6 Control voltage out and PID

**DAC** `DAC,val`

Set output voltage. `val` is 16-bit scaled to  $\pm 2.5$ V. `DAC,0` will set  $-2.5$ V, `DAC,0x7fff` will set 0V and `DAC,0xffff` will set  $+2.5$ V.

**DISABLE** `PID,DISABLE`

Deactivate the PID controller, setting the output voltage to the value specified by the `OFFSET` command (see below).

**ENABLE** `PID,ENABLE[,val]`

Activate the PID controller, producing the control voltage on the SMA output. If `val` is specified, it can be `0` or `off` to disable active feedback, or `1` or `on` to enable feedback.

**GAIN** `PID,GAIN[,val]`

Set/query the overall gain used for the PID controller in V/GHz. Use a negative gain to invert the feedback.

**KP, KI, KD** `PID,KP[,val]` or `PID,KI[,val]` or `PID,KD[,val]`

Set/query the PID coefficients  $K_p$ ,  $K_i$  and  $K_d$ , which are floating-point values in the range  $[0, 1]$ .

**MIN** `PID,MIN[,val]`

Set/query the minimum output voltage of the PID controller.

**MAX** `PID,MAX[,val]`

Set/query the maximum output voltage of the PID controller.

- OFFSET** `PID,OFFSET[,val]`  
Set/query the constant DC offset on the analogue output, in volts.
- SELECT** `PID,SELECT[,port]`  
Query or set the port selected for reporting or setting port-related parameters such as setpoint, gain, offset etc. If a fibre switch is connected, many of the PID commands listed below will refer to the port chosen by **SELECT**. That channel will not change when auto-stepping.
- SETPOINT** `PID,SET[,val]`  
Set/query the PID controller setpoint frequency, *in THz*. If `val` is `*`, uses the most recent measurement as the setpoint.
- STATUS** `PID,STATUS`  
Returns the current status of the PID controller.
- VALUE** `PID,VALUE`  
Returns the current output voltage of the PID controller for monitoring purposes.
- WRITE** `PID,WRITE,val`  
Sets output to `val` if in hex format (e.g. `0x1234`). `val` is 16-bit scaled to  $\pm 2.5\text{V}$ . `DAC,0` will set  $-2.5\text{V}$ , `DAC,0x7fff` will set  $0\text{V}$  and `DAC,0xffff` will set  $+2.5\text{V}$ .  
Sets output to offset (see above) plus `val` if `val` is a floating point number.

## B.7 Ethernet configuration

The default ethernet configuration is DHCP enabled. If DHCP negotiation fails, the fall-back static IP address is 10.1.1.190 with port 7802. TCP/IP parameters can be reconfigured through the on-device menu system (section 2.3.1), or using the commands below.

Please refer to our website, <https://www.moglabs.com/support/software/connection> for more information on connecting.

- 
- static** `ETH,static,"xxx.xxx.xxx.xxx"`  
Set static IP address based on decimal dotted-quad string (e.g. "10.1.1.190"). Note that the double-quotes are part of the syntax and must be included to delimit the IP address string.
- mask** `ETH,mask,"xxx.xxx.xxx.xxx"`  
Set IP mask based on dotted-quad string (e.g. "255.255.255.0").
- gw** `ETH,gw,"xxx.xxx.xxx.xxx"` or `ETH,gate,"xxx.xxx.xxx.xxx"`  
Set IP gateway based on dotted-quad string (e.g. "10.1.1.1").
- mac** `ETH,mac,"xx:xx:xx:xx:xx:xx"`  
Set the MAC address.
- port** `ETH,port,portnumber`  
Set the TCP/IP port number (default 7802) for device communication.
- dhcp** `ETH,dhcp,[off,on]`
- web** `ETH,web,[off,on]`  
Enable or disable DHCP or the integrated web server; both default to enabled. The argument can be `0`, `1`, `off`, `on`, `dis`, `en` where `dis`, `en` are for disable or enable.
- status** `ETH,stat` or `ETH,ipaddr` or `ETH,ip`  
Connection status.
- info** `ETH,info`  
Extended connection information.
- restart** `ETH,res`  
Restart the ethernet interface.

## C. Firmware updates

From time to time, MOGLabs will release updates to the device firmware which improve the device functionality. This section contains instructions on how to apply firmware updates to your device using the “Firmware Update Tool” available from the MOGLabs website as part of the host software suite.

**WARNING:** Do not attempt to communicate with the device while a firmware upgrade is being applied, and do not interrupt an upgrade (or factory reset) in progress.

1. Running the application will display diagnostic information about your device (Figure C.1). Ensure the serial number matches the device.
2. Press the “Select” button to choose a firmware package to use, as downloaded from the MOGLabs website.
3. The package is compared against the currently running version to determine which upgrades are required (Figure C.2). Up-to-date components are shown in green, upgrades are shown in yellow, downgrades in purple and conflicts in red.
4. Click on *Update all* to install all detected upgrades in sequence. Individual components can be installed by clicking the *Upload* option next to each item.
5. The device will reboot after every individual component upgrade, to ensure the upload was successful before moving on to the next component.
6. A dialog box will indicate the upgrade was successful and the device will be ready to use.

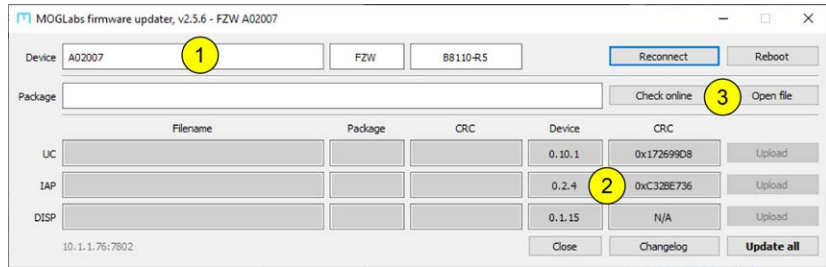

**Figure C.1:** The firmware update application connected to a FZW unit, showing (1) the device serial number and (2) current firmware versions. Click (3) the *Open file* button to open a firmware package for upload.

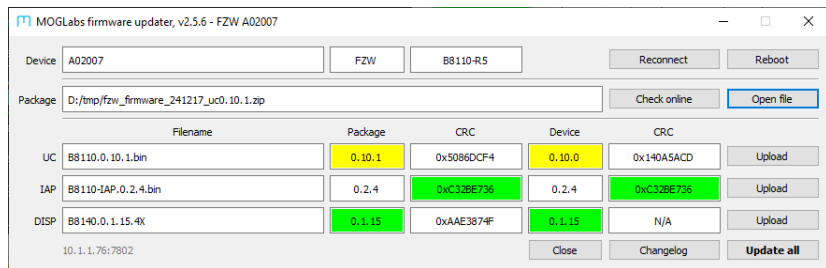

**Figure C.2:** The firmware update application with a loaded package. The versions running on the device are compared against the selected package, in this instance showing that an update is available for the UC (yellow) and other components are up-to-date (green).

# D. Errors and troubleshooting

**Comms failure** Error in communicating, for example imaging sensor or host. Can be caused by low voltage on the power supply, for example when using a USB port with insufficient current capacity. Try using a USB hub, or a DC power supply, and contact MOGLabs if this error persists.

**Over-exposed** Reduce exposure or reduce optical power at the input.

**Under-exposed** Increase exposure time or increase optical power at the input.

**Multi-mode** Typically occurs if the input light includes several frequencies, for example a broad linewidth laser, or a laser oscillating on two distinct longitudinal cavity modes. The FZW is unable to clearly determine the phase of the interference fringes; that is, where the peaks occur.

**Internal error** Indicates a bug in the software. Please contact MOGLabs if this occurs.

**Low contrast** The interference fringes are indistinct, due to broad background or the laser linewidth is too broad, or there are multiple laser frequencies in the input light.



# E. Communications

The FZW can be connected to a computer by USB or ethernet (TCP/IP) and the software package `mogfzw` (chapter 3) provides interactive functionality. Device control can also be integrated into existing control software following the protocol below using the commands in Appendix B.

Please refer to our website, <https://www.moglabs.com/support/software/connection> for more information on connecting.

## E.1 Protocol

Device communication follows a query/response protocol using CRLF-terminated ASCII strings. Statements are either *commands* or *queries* depending on whether they cause an action to occur. A command will always respond with OK or ERR as appropriate.

It is strongly recommended that all software should wait for this response and check for success before continuing. The `python` and `LabVIEW` bindings provided take care of buffering and error checking automatically.

The *MOGLabs Commander* application (`mogcmd`) is available as part of the `mogfzw` package and provides a convenient interface for sending commands and receiving responses (Figure E.1).

## E.2 TCP/IP

The FZW can be accessed over ethernet via the IPv4 protocol. When ethernet is connected, the FZW will attempt to obtain an IP address by DHCP. If DHCP fails, an internally defined address will be used. In both cases, the address will be shown on the device display (static default 10.1.1.190:7802), showing the address and port number for communicating with the device.

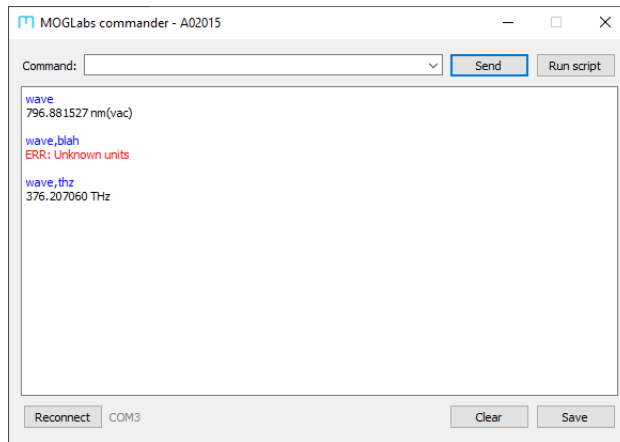

**Figure E.1:** The `mogcmd` application, showing successful and unsuccessful commands and queries.

### E.2.1 Changing IP address

Depending on your network settings you may need to manually set the IP address. This is most easily done via the front-panel interface as detailed below, but can also be done by the command interface (section B.7). Once configured, these settings are stored in the non-volatile memory of the unit and will be recalled in future.

1. From the main menu, open `Options > Ethernet Settings`.
2. Select *Static IP* and use the buttons to set the IP address of the device as required.
3. Select *Gateway* and set the gateway address as required.
4. Select *DHCP* and set to OFF.
5. Select *Restart ethernet* and press the OK button.
6. The new IP address will be displayed in the display footer.

In some situations it may be necessary to power-cycle the device to propagate ethernet changes.

## E.3 USB

The FZW can be directly connected to a host computer using a USB cable. The device will appear as a Virtual COM port, which behaves like an RS232 connection. The required STM32 Virtual COM Port Driver (VCP) device driver for the Windows™ operating system is available from the MOGLabs website. After installation, the FZW will appear as a COM port.

To determine the port number of the device, go to Device Manager (Start, then type Device Manager into the Search box). You should see a list of devices including Ports (Figure E.2).

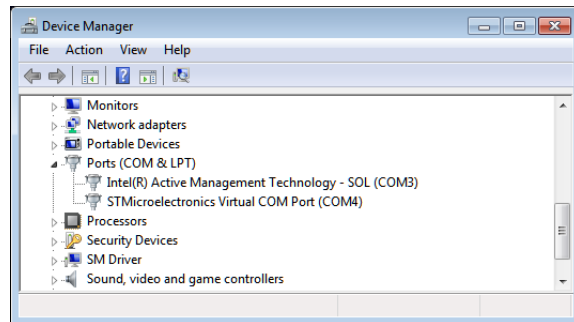

**Figure E.2:** Screenshot of Device Manager, showing that the FZW can be communicated with using COM4. The port number might change when plugging into a different USB port, or after applying a firmware update.

The device can be identified as a COM port with the following name, `STMicroelectronics Virtual COM Port (COMxx)` where `xx` is a number (typically between 4 and 15). In the example above, the device was installed as COM4.

Note that if the port appears in Device Manager with a different name, then the driver was not successfully installed. If this occurs,

disconnect the device from the host computer, reinstall the VCP driver (see below), then reconnect the USB cable.

### E.3.1 USB driver

If you do not see a virtual COM port under `Ports` in the `Device Manager` then manually install the USB driver, which is available from the MOGLabs website. More detailed instructions are also available on the website.

1. Ensure the wavemeter is **disconnected** from the computer.
2. Run the 32-bit or 64-bit USB driver setup program from the package as appropriate for your computer system (note that all modern computers are 64-bit).
3. Reconnect the wavemeter using the USB cable. The device driver will be activated, which may take up to a minute.
4. The device should be installed as a `Virtual COM Port` as described above.
5. Run the `mogfzw` host application to verify that the detection was successful.

# F. Dimensions and PCB

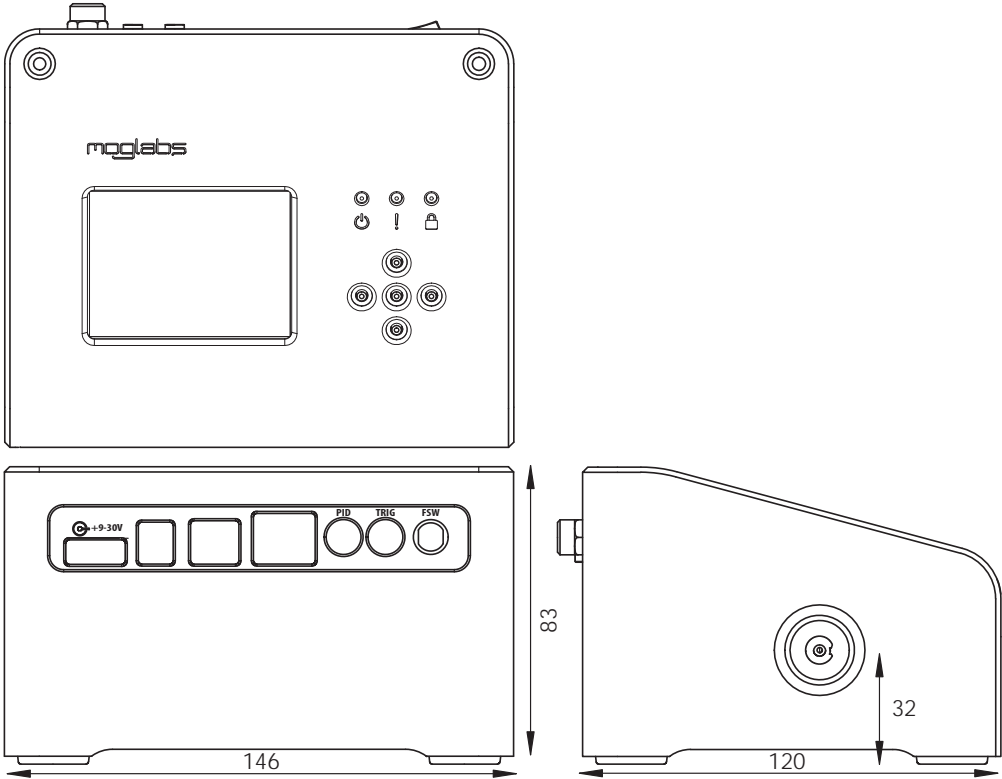

Figure F.1: FZW chassis dimensions.

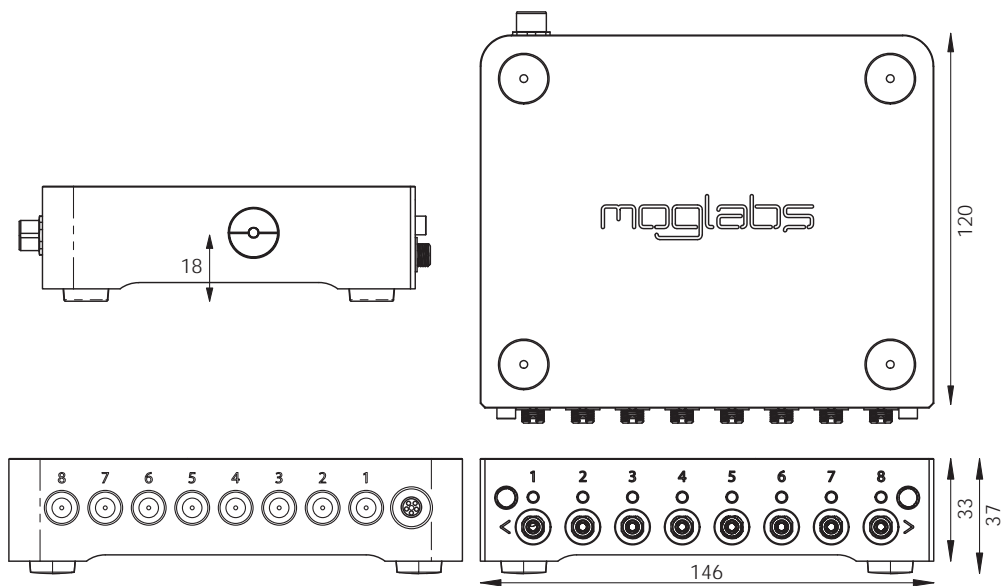

Figure F.2: FSW fibre switch dimensions.

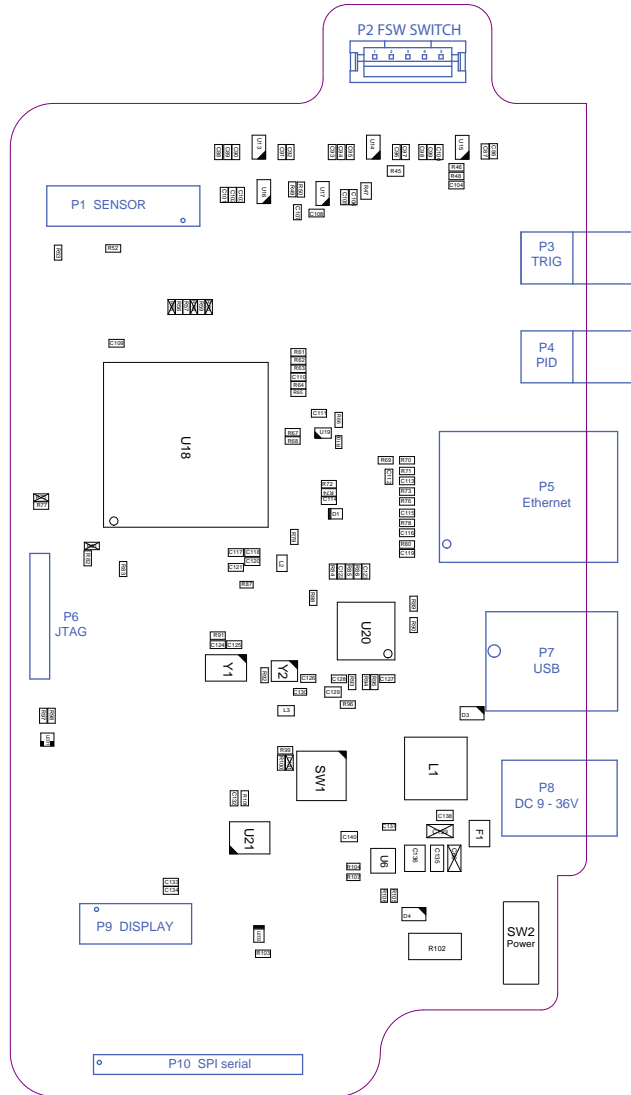
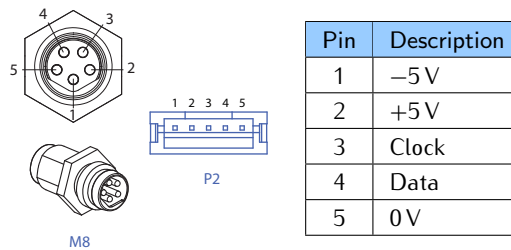

Figure F.3: FZW main PCB.

## F.1 Connectors



**Figure F.4:** Fibre switch connectors: External M8 and P2 on main PCB (type JST type B5B-PH-SM4-TB(LF)(SN). Use Data as TTL control signal for simple 2x1 switches.

| Pin | Description |
|-----|-------------|
| 1   | 0V          |
| 2   | Clock       |
| 3   | Ready       |
| 4   | NSS         |
| 5   | MISO        |
| 6   | MOSI        |
| 7   | 0V          |
| 8   | See P12     |
| 9   | 0V          |
| 10  | See P13     |

**Figure F.5:** P10 connector on main PCB, for OEM serial communications.

| P12 | Description                     |
|-----|---------------------------------|
| 1-2 | P10 pin 8 = +5V out             |
| 2-3 | P10 pin 8 = +3.3V (digital) out |

| P13 |                                   |
|-----|-----------------------------------|
| 1-2 | P10 pin 10 = +24V in or out       |
| 2-3 | P10 pin 10 = +3.3V (analogue) out |

**Figure F.6:** Use jumpers on P12 and P13 to control P10 pins 8 and 10. Short-circuit pins 1,2 or 2,3 on P12 as indicated for +5V or +3.3V (analogue) output on P10 pin 8. Short-circuit pins 1,2 or 2,3 on P13 for +24V (input or output) or +3.3V (digital) output, on P10 pin 10.





